

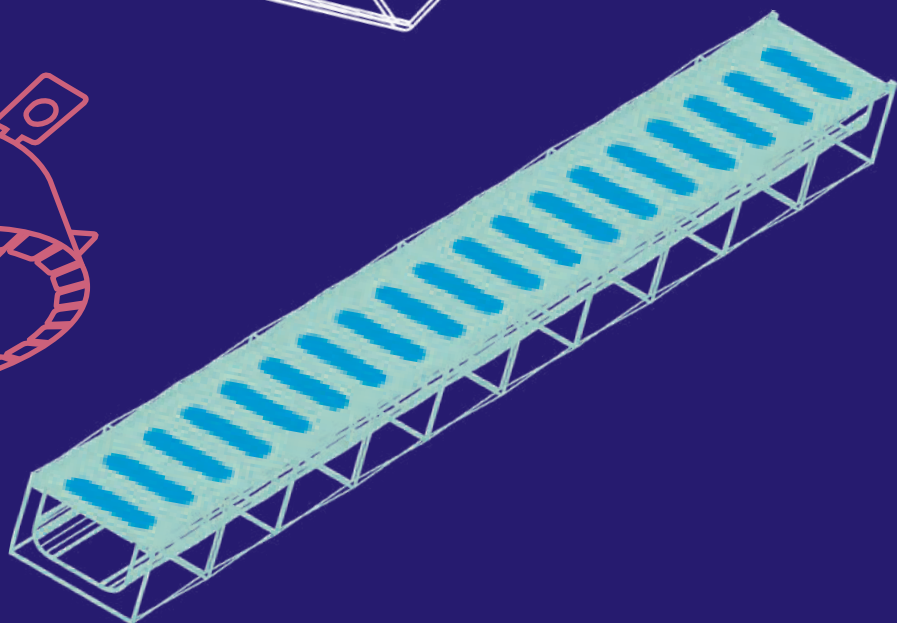

HYDRAFIX

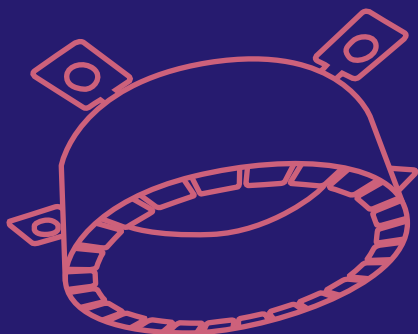
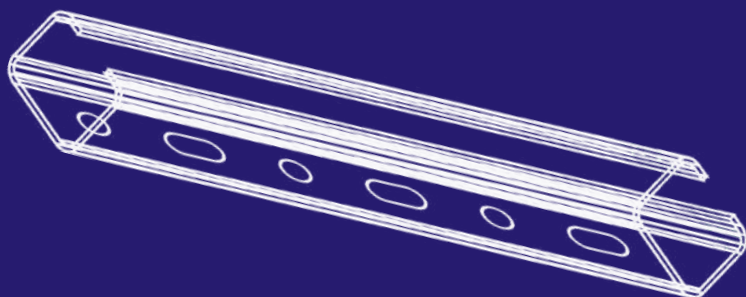
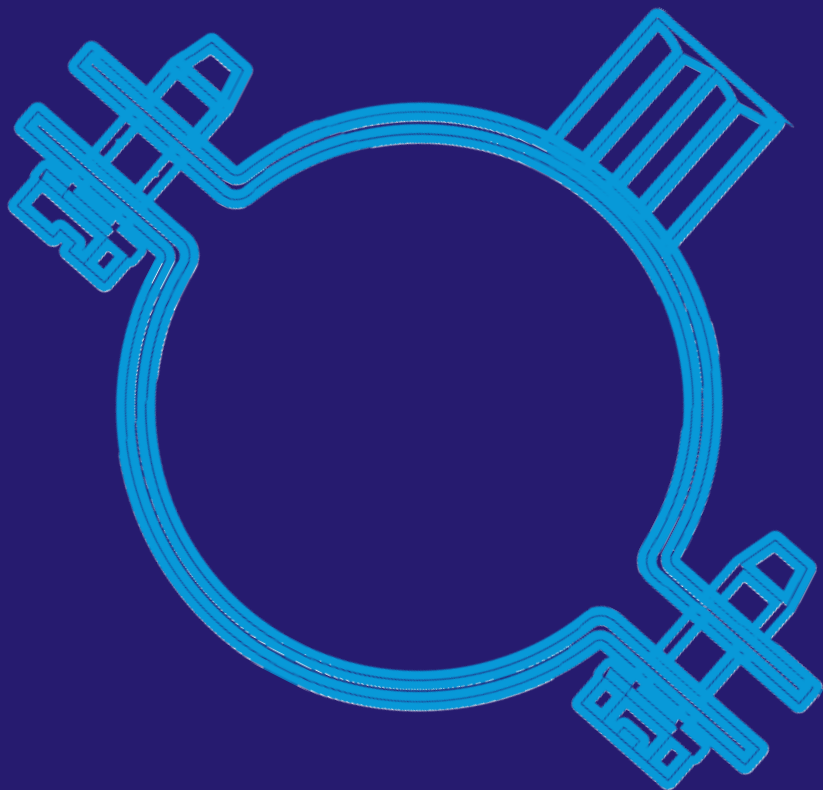

TARIFA 2022-2023

TARIFA DE PRECIOS 2022-2023

Tenemos la satisfacción de presentarles nuestro CATÁLOGO-TARIFA 2022-2023. Continuamos manteniendo la calidad que caracteriza a nuestros productos habituales, añadiendo además algunas novedades:

- Abrazadera M8+M10 Hydramix etiquetada individual. Novedad | Pág. 20
- Abrazadera M8+M10 Hydramix isófonica etiquetada individual. Novedad | Pág. 20
- Reja ranura central altura 2,5 cm en acero galva para canal HS100. Novedad | Pág. 101
- Reja ranura central altura 10 cm en acero galva para canal HS100. Novedad | Pág. 101
- Canal HSP2 + Reja de plástico blanco. Novedad | Pág. 109

■ HYDRAFIX

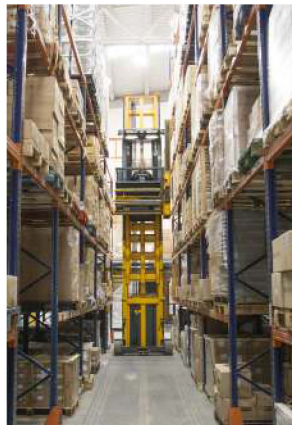

Estos diseños han cambiado el mercado...

ABRAZADERA MÚLTIPLE HYDRA 1000

Ref. 1329

Con tres medidas de abrazaderas
15-18, 20-25 y 25-32 fijamos
10 diámetros



Se fija al soporte con tirafondo M6.
Tirafondo normal. Tiro de pistola.



Vale para guías:

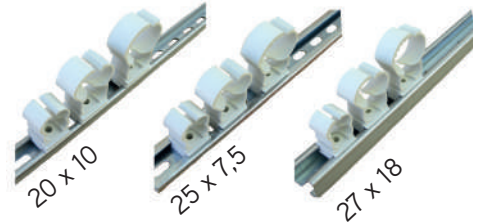

NOVEDAD
New



ABRAZADERA M8 HYDRA 8000

Ref. 1800

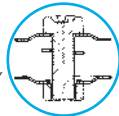
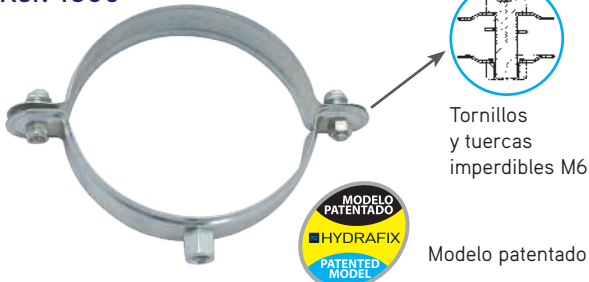

Tornillos
y tuercas
imperdibles M6



Modelo patentado

ABRAZADERA M8 HYDRA 8000 BLANCA

Ref. 5705AB

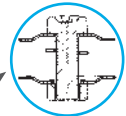
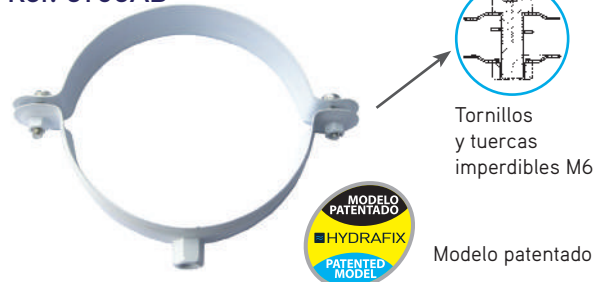

Tornillos
y tuercas
imperdibles M6



Modelo patentado

ABRAZADERA ISOFÓNICA M8 + M10 HYDRASOL MOD. "D" SOLDADAS POR CORDÓN

Ref. 1510D



Acabado con protección
superior RNS1000.



Soldadura por cordón

ABRAZADERA M8 + M10 HYDRASOL MOD. "D" SOLDADAS POR CORDÓN

Ref. 1400D



Acabado con protección
superior RNS1000.



Soldadura por cordón

SOPORTE PARA PLACA Y TEJA

Ref. 7100D



Ref. 7100F



AMPLIA GAMA DE COLLARINES INTUMESCENTES

Ref. AFG



...y por supuesto son de

 **HYDRAFIX**

Denominación	Foto	Pág.	Ref.
ABRAZADERAS METÁLICAS REFORZADAS			
Abrazadera Isofónica M8 + M10 Hydramix <i>Disponible en Autoservicio</i>		18	1511
Abrazadera M8 + M10 Hydramix <i>Disponible en Autoservicio</i>		19	1401
Abrazadera M8 + M10 Hydramix Etiquetado individual Novedad		20	B1401
Abrazadera Isofónica M8 + M10 Hydramix Etiquetado individual Novedad		20	B1511
Abrazadera Isofónica M8 + M10 Hydrasol "D"		21	1510D
Abrazadera M8 + M10 Hydrasol "D"		21	1400D
Abrazadera Hydrades isofónica M8 + M10 1T		22	1513
Abrazadera Hydrades isofónica M8 + M10 2T		22	1514
Abrazadera M8 Hydra 8000		23	1800
Abrazadera M8 Hydra 8000 Blanca		23	5705AB
Tornillo carril M6 x 10		24	1940
Soporte isofónico		24	1960
Abrazadera HCV Homologada		24	14702
Abrazadera empotrar PVC reforzada		25	1710
Abrazadera tipo "U"		25	1730
Abrazadera empotrar PVC Hydra 7000		25	1700
Abrazadera regulable		26	1750
Abrazadera M8 CTA amarilla		26	1407
Abrazadera M8+M10 CTA amarilla		26	1407H
Abarcón		27	1420

Denominación	Foto	Pág.	Ref.
Abrazadera súper etiquetada individual		28	B1610
Abrazadera súper		28	1610
Abrazadera Isofónica M8 Hydralig		29	1414
Soporte Abarcón altura 100		29	1422
Soporte Abarcón altura 50		29	1422
ABRAZADERAS METÁLICAS LIGERAS			
Abrazadera M6 <i>Disponible en Autoservicio</i>		31	1100
Abrazadera doble M6 <i>Disponible en Autoservicio</i>		31	1120
Tirafondo abrazadera <i>Disponible en Autoservicio</i>		31	2100
Abrazadera Isofónica M6 G/E <i>Disponible en Autoservicio</i>		32	1107
Abrazadera Isofónica doble M6 G/E <i>Disponible en Autoservicio</i>		32	1108
Abrazadera M6 con tirafondo		33	1110
Abrazadera doble M6 con tirafondo		33	1220
Abrazadera M6 cromada		33	1101
Abrazadera M6 CTF negra con tirafondo		34	1103
Abrazadera M6 CTA amarilla con tirafondo		34	1215
Florón abrazadera M6		34	2102
Abrazadera BTN		34	1620
Abrazadera sin fin <i>Disponible en Autoservicio</i>		35	1600
Abrazadera sin fin etiquetada individual		35	B 1600
Tirafondo grapa		35	2110

Denominación	Foto	Pág.	Ref.
Grapa 1 pie <i>Disponible en Autoservicio</i>		36	1910
Grapa puente		36	1920
ABRAZADERAS DE PLÁSTICO			
Abrazadera múltiple Hydra 1000 nylon <i>Disponible en Autoservicio</i>		38	1329
Clip M6 nylon <i>Disponible en Autoservicio</i>		39	1311
Clip doble M6 nylon <i>Disponible en Autoservicio</i>		39	1312
Fix-ring nylon		39	1340
Fix-ring doble nylon		39	1342
Abrazadera cierre <i>Disponible en Autoservicio</i>		40	1300
Abrazadera cierre nylon		40	1333
Pinza nylon		40	1310
Abrazadera Hydractn nylon		41	1360
Abrazadera Hydractn doble nylon		41	1362
ACCESORIOS DE MONTAJE			
Manguito hexagonal <i>Disponible en Autoservicio</i>		43	2300
Manguito redondo		43	2305
Espárrago con separador		43	2310
Espárrago <i>Disponible en Autoservicio</i>		43	2311
Juego tirafondos soporte calentadores <i>Disponible en Autoservicio</i>		44	2550
Tirafondo barraquero		44	2940
Juego de alcayatas <i>Disponible en Autoservicio</i>		44	2555

Denominación	Foto	Pág.	Ref.
Tornillo Pozi		44	2115
Vuelco espiga		45	2720
Vuelco gancho		45	2730
Arpón espiga		45	2740E
Arpón gancho		45	2740G
Cabeza basculante		45	2700CB
Cabeza arpón		45	2700CA
Tuerca hexagonal <i>Disponible en Autoservicio</i>		46	2910
Tuerca autoblocante		46	2912
Arandela plana		46	2920
Arandela plana ancha		46	2930
Tornillo DIN 931		46	2931
Tornillo DIN 933		47	2950
Tirafondo hembra		47	2101
Tacos+Tornillo hexagonal para fachadas		47	9430
Varilla roscada		48	2900
Tirafondo doble rosca (Dowell)		48	2103
Tirafondo abrazadera		48	2100
Broca acero súper rápido HSS		49	2670
Broca de "Widia"		49	2600
Broca Óptima		49	2610

Denominación	Foto	Pág.	Ref.
Broca SDS Plus		49	2650
Cinta perforada		50	1900
Soporte frontal contador de gas		50	2400J
Soporte lateral contador de gas		50	2400K
Soporte contador de gas frontal acero inox. Aisi 316 con accesorios		51	2400JI
Soporte lateral contador de gas frontal acero inox. Aisi 316		51	2400KI
Soporte de radiador tipo A. Columnas empotrar		52	2400A
Soporte de radiador tipo B. Alicatar		52	2400B
Soporte de radiador tipo B2. Alicatar 90 mm para 1"		52	2400B2
Soporte de radiador tipo C. Para radiador Ferroli empotrar 1"		52	2400C
Soporte de radiador tipo G. Uña aluminio		52	2400G
Soporte de radiador tipo H. Tipo rayco		52	2400H
Soporte de radiador regulable tipo M.		53	2400MG
Soporte de radiador regulable tipo M. Bolsa dos conjuntos soporte triangular <i>Disponible en Autoservicio</i>		53	2400M
Soporte de radiador regulable tipo D. Bolsa dos conjuntos alicatar Ferroli <i>Disponible en Autoservicio</i>		53	2400D
Soporte de radiador regulable tipo I. Bolsa dos conjuntos aluminio oculto <i>Disponible en Autoservicio</i>		53	2400I
Bolsas de sanitario conjunto A. Lavabo <i>Disponible en Autoservicio</i>		54	2500A
Bolsas de sanitario conjunto C. Vertical <i>Disponible en Autoservicio</i>		54	2500C
Bolsas de sanitario conjunto D. Horizontal (tipo górgola) <i>Disponible en Autoservicio</i>		54	2500D
Bolsa dos unidades Fijación WC horizontal.		54	2500E
Tornillo taza		54	2500F

Denominación	Foto	Pág.	Ref.
ANCLAJES			
Anclaje hembra <i>Disponible en Autoservicio</i>		56	9200
Anclaje hembra homologado		56	9200H
Expansionador manual anclaje hembra		56	9205
Taco latón		56	9250
Anclaje macho		56	9100
Anclaje CH tornillo <i>Disponible en Autoservicio</i>		57	9300T
Anclaje CH espárrago		57	9300E
Anclaje CH gancho <i>Disponible en Autoservicio</i>		57	9300G
Anclaje CH argolla <i>Disponible en Autoservicio</i>		57	9300A
Resina de poliéster		58	9600C
Espárrago con tuerca y arandela		58	9600E
Tamiz de plástico		58	9600T
Pistola cartucho		58	9600P
Mezclador		58	9600M
TACOS DE PLÁSTICO Y BRIDAS			
Bridas nylon negras		60	2990
Taco brida nylon negro		60	2999
Bridas nylon blancas		60	2980
Taco brida nylon blanco		60	2999
Taco nylon		61	2200

Denominación	Foto	Pág.	Ref.
Taco gris		61	2205
Taco nylon con valona		61	2202
Taco arpón		61	2230A
Taco Plusx nylon		62	2225
Bote taco Plusx nylon		62	2225B
Expositor bote taco Plusx nylon		62	2225BEXP1
Taco de plástico tres cortes <i>Disponible en Autoservicio</i>		63	2210
Taco de plástico dos cortes <i>Disponible en Autoservicio</i>		63	2215
Taco autotaladrante pladur		63	2230A
Taco rápido M6 / M8		64	9410
Taco rápido		64	9400

ABRAZADERAS Y ACCESORIOS EN ACERO INOXIDABLE

Abrazadera M8 acero inoxidable Aisi 304		66	1409
Abrazadera Isofónica M8 acero inoxidable Aisi 304		66	1509
Abarcón acero inoxidable Aisi 304		67	1430
Cinta perforada inoxidable Aisi 430		67	1903
Anclaje hembra acero inoxidable Aisi 316		67	9201
Abrazadera M8 + M10 acero inoxidable Aisi 316		68	1403
Abrazadera Isofónica M8 + M10 acero inoxidable Aisi 316		68	1503
Abrazadera M6 acero inoxidable Aisi 304		69	1416
Abrazadera M6 Hydratube inox Aisi 304		69	1419

Denominación	Foto	Pág.	Ref.
Tirafondo abrazadera acero inoxidable Aisi 304		69	2104
Tirafondo doble rosca (Dowell) acero inoxidable Aisi 304		70	2105
Abrazadera sin fin acero inoxidable Aisi 304 con tornillo inox		70	1605
Arandela plana acero inoxidable Aisi 304		70	2923
Anclaje CH acero inoxidable Aisi 304 <i>Disponible en Autoservicio</i>		70	9310
Varilla roscada acero inoxidable Aisi 304		71	2903
Manguito hexagonal acero inoxidable Aisi 304		71	2330
Tuerca hexagonal acero inoxidable Aisi 304		71	2913

SOPORTACIÓN

Guía metálica de 1 m longitud de 25 x 7,5 x 0,8		73	1300GM
Guía metálica de 2 m longitud de 20 x 10 x 1		73	1333GM2
Guía metálica de 2 m longitud de 27 x 18 x 1,25		73	1590G2718
Guía metálica de 2 m longitud de 28 x 30 x 1,75		73	1590G2830
Guía metálica de 2 m longitud de 38 x 40 x 2		73	1590G3840
Guía metálica de 2 m longitud de 40 x 20 x 1,5		73	1590G4020
Guía metálica Strut de 41 x 41 x 2,5		73	1590G44125
Guía metálica Strut de 41 x 21 x 2		73	1590G42120
Tornillo M6 x 10		73	1940
Soporte 27 x 18 x 1,25		74	1590S
Soporte 38 x 40 x 2		74	1590S
Soporte 41 x 41 x 2,5		75	1590S

Denominación	Foto	Pág.	Ref.
Escuadra 90º		75	1590E
Escuadra 135º		75	1590E
Soporte horizontal		76	1590SH
Soporte vertical		76	1590SV
Soporte apoyo horizontal		76	1590SAH
Mordaza para viga fundición		77	1590M
Mordaza para viga chapa		77	1590MCH
Tornillo guía 27-18 y 28-30		78	1590TG
Tornillo guía 38-40 y 40-20		78	1590TG
Tornillo guía Strut 41 x 41		78	1590TG
Tuerca guía 27-18, 28-30 y 38-40		78	1590TU
Tuerca guía strut fijación rápida		79	1590TSR
Tuerca guía Strut 41 x 41		79	1590TR
Tuerca guía Strut con muelle 41 x 41		79	1590TM
INTUMESCENTE			
Collarín intumescente HN		81	22600
Collarín intumescente HV		81	22200
Anclaje cuña 6 x 40		81	92100
Collarín intumescente HC		82	22300
Rejilla intumescente		82	3250
Saquito intumescente		82	AFB

Denominación	Foto	Pág.	Ref.
Collarín intumescente "C" acero inoxidable		83	AFG
Ladrillo intumescente		83	AFL
Collarín intumescente acero inoxidable		84	AFG
Collarín intumescente B3 acero inoxidable		85	AFG3
Multicollarín intumescente acero inoxidable		86	AFG300
VENTILACIÓN			
Rejillas de aluminio 15 x 15		88	310015
Rejillas de aluminio 16 x 16 Empotrar		88	310016
Rejillas de aluminio 17 x 17		88	310017
Rejillas de aluminio 20 x 20		89	310020
Rejilla de aluminio 20 x 20 Empotrar		89	310020
Rejilla de aluminio 30 x 15		89	310030
Rejilla de aluminio 30 x 30		89	31003030
Rejilla de aluminio con mosquitera 15 x 15		90	311115
Rejilla de aluminio con mosquitera 17 x 17		90	311117
Rejilla de aluminio con mosquitera 20 x 20		90	311120
Rejilla de plástico vertical 13 x 26 c/marco		91	3500AN
Rejilla de plástico vertical con marco cierre		91	3500IN
Mosquitera vertical 9 x 21,5		91	3500JN
Rejillas de plástico con red 15 x 20		91	3500K
Rejilla de plástico con red 23 x 23 lisa		91	3500P

Denominación	Foto	Pág.	Ref.
Rejilla plástico con red Multi desde Ø125 a Ø170 mm		92	3500R
Rejilla de plástico Multi desde Ø140 a Ø200 mm		92	3500S
Rejilla plástico con red Redonda Ø120		92	3500N
Rejilla de plástico multi desde Ø90 a Ø125 mm		92	3500MN
Rejilla metálica AMT-AN		93	3203
Rejilla metálica AMT-AN		93	3207

DEFLECTORES Y TUBO FLEXIBLE DE ALUMINIO

Deflector eólico redondo		95	4153
Deflector eólico cuadrado		95	4153
Extractor eléctrico tiro forzado		95	4152
Deflector brisa redondo acero inoxidable Aisi 304		96	4165
Deflector brisa cuadrado acero inoxidable Aisi 304		96	4165
Deflector Stratos		96	4149
Deflector 3 discos chapa de acero blanco para tubo de aluminio flexible		97	4103
Deflector 3 discos aluminio blanco para tubo de aluminio flexible		97	5704D3
Deflector acero inoxidable "N" para tubo de aluminio flexible		97	4105
Deflector 3 discos chapa de acero blanco para tubo de aluminio rígido		97	4102
Deflector 3 discos de aluminio blanco para tubo de aluminio rígido		98	5704M
Tubo flexible aluminio		98	5100

CANALES DE DRENAJE

Canal HS de 100 x 50 de 1 m de longitud		100	38600C100
---	--	-----	-----------

Denominación	Foto	Pág.	Ref.
Canal HS de 100 x 100 de 1 m de longitud		100	38600C101
Canal HS de 100 x 150 de 1 m de longitud		100	38600C102
Reja Plástico negra A15 para canal HS modelo 100		101	38600R100
Reja Pasarela acero galvanizado A15 para canal HS modelo 100		101	38600R101
Reja Composite negra B125 para canal HS modelo 100		101	38600R104
Reja Entramada 30x30 acero galvanizado B125 canal HS modelo 100		101	38600R105
Reja Composite negra C250 para canal HS modelo 100		101	38600R108
Reja Antitacón Fundición dúctil C250 para canal HS modelo 100		101	38600R109A
Reja Fundición dúctil C250 para canal HS modelo 100		101	38600R109
Reja Piscina acero inox. Aisi 316 A15 para canal HS modelo 100		101	38600R120
Reja Ranura central altura 2,5 cm acero galva para canal HS modelo 100 Novedad		101	38600R130
Reja Ranura central altura 10 cm acero galva para canal HS modelo 100 Novedad		101	38600R131
Canal HS de 150 x 100 de 1 m de longitud		102	38600C150
Canal HS de 150 x 150 de 1 m de longitud		102	38600C151
Reja Pasarela acero galvanizado A15 para canal HS modelo 150		103	38600R151
Reja Composite negra B125 para canal HS modelo 150		103	38600R154
Reja Entramada 30x30 acero galvanizado B125 canal HS modelo 150		103	38600R155
Reja Fundición dúctil C250 para canal HS modelo 150		103	38600R159
Canal HS de 200 x 100 de 1 m de longitud		104	38600C200
Canal HS de 200 x 150 de 1 m de longitud		104	38600C201
Reja entramada 30 x 30 acero galvanizado B125 para canal HS modelo 200		104	38600R205

Denominación	Foto	Pág.	Ref.	Denominación	Foto	Pág.	Ref.
Reja Fundición dúctil C250 para canal HS modelo 200		104	38600R209	Reja ranura central 100-25 mm Acero galvanizado para canal Basic		110	38410R100
Canal HX modelo 100/100 + Reja de fundición dúctil D400, montadas sobre bastidor y tornillos.		105	38610D101	Reja ranura central 100-25 mm Acero inoxidable para canal Basic		110	38410R102
Canal HX modelo 150/150 + Reja de fundición dúctil D400, montadas sobre bastidor y tornillos.		105	38610D151	Reja ranura central 100-100 mm Acero galvanizado para canal Basic		110	38410R101
Canal HX modelo 200/150 + Reja de fundición dúctil D400, montadas sobre bastidor y tornillos.		105	38610D201	Reja ranura central 100-100 mm Acero inoxidable para canal Basic		110	38410R103
Canal HX modelo 300/200 + Rejas de fundición dúctil D400, montadas sobre bastidor y tornillos.		106	38610D301	Registro ranura central 100-25mm Acero galvanizado para canal Basic		110	38410RR100
Rejillas entramadas de 33 x 33 con marco galvanizadas peatonales		106	37300	Registro ranura central 100-25mm Acero inoxidable para canal Basic		110	38410RR102
Rejillas entramadas de 33 x 33 con marco galvanizadas peatonales		106	37300	Registro ranura central 100-100mm Acero galvanizado para canal Basic		110	38410RR101
Rejillas entramadas de 33 x 10 con marco galvanizadas peatonales		106	37100	Registro ranura central 100-100mm Acero inoxidable para canal Basic		110	38410RR103
Canal HSB de 100 x 50 de 1 m de longitud		107	38607C100	Módulos rejilla modular piscina modelo estrecho.		111	36350
Canal HSB de 100 x 100 de 1 m de longitud		107	38607C101	Módulos rejilla modular piscina modelo ondulado.		111	36350
Reja Pasarela de Acero galvanizado A15 para canal HSB de 100		107	38607R101	Módulos rejilla modular piscina modelo recto.		111	36350
Canal HSP1 con Rejas de Plástico negro A15		108	38401CRN	Perfil módulo rejilla piscina		111	36350P2
Canal HSP1 con Rejas de Plástico gris A15		108	38401CRG	Ecocanal modelo 200 negro de 1 m de longitud		112	36520CN
Canal HSP1 con Reja Galvanizada A15		108	38401CRP	Ecocanal modelo 200 gris de 1 m de longitud		112	36520CG
Canal HSP2 con Reja de Plástico negro A15		109	38402CRN	Reja Pasarela plástico negra para Ecocanal modelo 200		112	36520RN
Canal HSP2 con Reja de Plástico gris A15		109	38402CRG	Reja Pasarela plástico gris para Ecocanal modelo 200		112	36520RG
Canal HSP2 con Reja de Plástico blanco A15 Novedad		109	38402CRB	Módulo canal 130 x 76		113	36130M75
Canal HSP2 con Reja Galvanizada A15		109	38402CRP	Módulo canal 130 x 140		113	36130M140
Canal Basic 100x46 de 1 m de longitud		110	38410C100	Reja reforzada para módulo canal 130		113	36130RR
Canal Basic 100x56 de 1 m de longitud		110	38410C101	Módulo canal de 200 x 160		114	36130M200
Canal Basic 100x85 de 1 m de longitud		110	38410C102	Reja reforzada para módulo canal 200		114	36130RR200

Denominación	Foto	Pág.	Ref.
SOPORTES DE CANALÓN			
Soporte en acero cincado con tornillos y tuercas. Soporte curvado placa 25 x 3,5		116	7100D
Soporte en acero cincado con tornillos y tuercas. Soporte curvado teja 25 x 3,5		116	7100F
Soporte acero galvanizado curvado placa 20 x 3 con tornillos y tuercas.		116	7100P
Soporte acero galvanizado curvado teja 20 x 3 con tornillos y tuercas.		116	7100T
Soporte en acero cincado con tornillos y tuercas, curvado Sandwich 23 x 3,5		116	7100S
Soporte en acero cincado con tornillos y tuercas. Curvado niko 25 x 2,5		117	7100N
Soporte en acero cincado regulable con tornillos y tuercas. Soporte 24 x 4 regulable.		117	7100J
Tornillo cabeza redonda cuello cuadrado con tuerca.		117	7101
Soporte en cobre con tornillos y tuercas, curvado teja 25 x 3,5		117	7100FCUN
Soporte angular metálico 400x25x2,5 con tornillos y tuercas.		118	7100A
Soporte angular metálico 400x25x4 con tornillos y tuercas.		118	7100B
Soporte angular metálico con tornillos y tuercas.		118	7100C
Soporte recto metálico con tornillos y tuercas.		118	7100E
Soporte metálico de clavar.		118	7100H
Módulo metálico para canalón PVC.		119	7110
Gancho para canalón tipo Epe.		119	7200
Gancho recto para canalón tipo Epe y Aíscindel.		119	7210
Cartela para canalón tipo Epe.		119	7300

FIJACIÓN DE CUBIERTA			
Ganchos con tuerca Ø6		121	8100

Denominación	Foto	Pág.	Ref.
Ganchos con tuerca Ø7		121	8200
Arandela		122	8300
Tornillo salomónico		122	8500
Apoyaondas		122	8600
Tuerca cuadrada para gancho		122	8400
Tornillo autorroscante con arandela Ø16		122	9500
Tornillo punta broca con arandela Ø16		123	9210
Tornillo punta broca con arandela Ø16		123	9210

FUNDICIÓN DE ALUMINIO			
Sumidero de Aluminio		125	6100
Sumidero económico		125	6101
Tapa registro de aluminio con marco estancia.		125	6140B
Tapa registro de aluminio con marco estancia y rellenable.		125	6140BR
Tapa de contador para pared en fundición de aluminio T.C.C.		126	6120
Llave T.C.C.		126	6120LL
Cerradura T.C.C. con llave		126	6120CCLL
Llave allen nº 5		126	61115
Tapa registro para suelo en aluminio con marco cierre por tornillo allen inoxidable		126	6110

TAPAS Y PUERTAS DE CONTADOR			
Tapa rellenable metálica acero inoxidable Aisi 304		128	37500I
Tapa rellenable galvanizada 10/10		128	37500

Denominación	Foto	Pág.	Ref.
Tapa rellenable galvanizada 20/10 reforzada		128	37600
Tapa cisterna galvanizada		129	37400
Tapa estanca con marco en fibra de vidrio y resina		129	35100
Tapa de contador de acero galvanizado rellenable para pared		129	37700
Tapa de contador de acero galvanizado para pared		130	37800G
Tapa de contador de acero inoxidable para pared		130	37800I
Tapa de contador con marco, visor y cerradura en poliestireno.		130	35900
Tapa de contador con caja, visor y cerradura en poliestireno.		130	35900
Tapa contador con marco y cerradura en poliestireno		131	35900
Tapa contador con caja y cerradura en poliestireno		131	35900
Tapa de contador con marco y cerradura en poliéster reforzada con fibra de vidrio		131	35500
Tapa de contador con marco y cerradura en poliéster reforzada con fibra de vidrio		131	35500

FUNDICIÓN DE HIERRO

Imbornal con marco. Tipo A		133	6700
Imbornal con marco. Tipo B		133	6700
Imbornal con marco. Tipo C		133	6700
Sumidero sifónico polipropileno		133	6700SP
Tapa cuadrada con marco B125		134	6610
Tapa cuadrada con marco 250 KN		134	6620
Tapa cuadrada reforzada con marco C250		134	6620C
Tapa cuadrada reforzada con marco D400		134	6640D

Denominación	Foto	Pág.	Ref.
Tapa redonda con marco		135	6510
Sumidero de hierro		135	6800
Sumidero de hierro ligero		135	6800L
Tubo bajante de canalón en hierro de 2 m		136	6900
Tubo bajante de canalón en hierro de 2 m con codo		136	6900C
Abrazadera para el tubo bajante de fundición de hierro		136	11400

EVACUACIÓN DE AGUA EN PLÁSTICO

Arqueta eléctrica con tapa. Plástico gris		138	36105E
Tapa con asas y marco 65 x 65. Plástico gris		138	36104TAM
Tapa con marco y sumidero. Plástico gris		138	36104S
Tapa registro rellenable con marco. Plástico gris		138	36104R
Tapa reforzada. Plástico gris		139	36104
Rejilla reforzada. Plástico gris		139	36103
Tapa con asa. Plástico gris		139	36104TA
Tapa ligera. Plástico gris		139	36104TN
Arqueta. Plástico gris		140	36105
Marco. Plástico gris		140	36102
Junta de goma termoplástica		140	36106
Sifón placa para arqueta. Plástico gris		140	36107
Sumidero salida vertical. Plástico gris		141	36100
Sumidero salida horizontal. Plástico gris		141	36100H

Denominación	Foto	Pág.	Ref.
Parahojas universal plástico		141	36101PUP
Parahojas universal metálico		141	36101PUM
Tapa con marco 700x700 clase A15		141	38400T
Arqueta jardín		141	36450
Boca desagüe sifónica con rejilla		142	36101S
Boca desagüe. Para tubo PVC. Tipo A		142	36101
Boca desagüe. Angular 90º 100 x 100. Tipo B		142	36101
Racord angular salida Ø100. Tipo C		142	36101
Boca desagüe. Racord angular 90º salida Ø110. Tipo D		142	36101
Protector Anti-pájaros		142	36101
Tapa reforzada. Plástico negro		143	36504
Rejilla reforzada. Plástico negro		143	36503
Marco. Plástico negro		143	36502
Arqueta. Plástico negro		143	36505
Sifón placa para arqueta		143	36507

COMPLEMENTOS















Sumidero de PVC con cazoleta y rejilla acero inox. salida horizontal/vertical		145	36230
Sumidero con PVC con rejilla acero inoxidable. Salida horizontal/vertical		145	36220
Sumidero de PVC con rejilla acero inoxidable baja cota, salida vertical		145	36220V
Sumidero acero inoxidable Aisi 304		146	69400
Sumidero de PVC con cazoleta, salida horizontal y vertical		146	36206

Denominación	Foto	Pág.	Ref.
Sumidero de PVC con cazoleta, salida vertical		146	36200
Sumidero de PVC, salida vertical, baja cota		146	36100PVC
Cinta de aluminio (50 m)		147	55555
Cinta americana (10 o 50 m)		147	55555
Precinto de embalar (132 m)		147	85100
Film de embalar estirable manual		147	85100
Disco abrasivo para hierro		148	8900H
Disco abrasivo para piedra		148	8900P
Disco diamante general de obra		148	88100
Disco diamante especial porcelánico		148	88105
Manguera butano		149	89096
Tubo cristal		149	89200
Gárgola plástico abierta blanca		149	36109P
Gárgola Marmores abierta		149	36109A

AUTOSERVICIO

Abrazadera M6		151	A1100
Abrazadera doble M6		151	A1120
Abrazadera isofónica M6 G/E		151	A1107
Abrazadera isofónica doble M6 G/E		151	A1108
Abrazadera isofónica M8 + M10 Hydramix con taco y tirafondo Dowell M8 x 90		152	A151B
Abrazadera M8 + M10 Hydramix con taco y tirafondo Dowell M8 x 90		152	A140B

Denominación	Foto	Pág.	Ref.	Denominación	Foto	Pág.	Ref.
Abrazadera M6 cromada		152	A1101	Tuerca hexagonal		158	A2910
Abrazadera M6 CFT negra con tirafondo		152	A1103	Arandela plana ancha		158	A2930
Abrazadera M8 Hydra 8000 con taco y tirafondo		153	A180A	Tuerca hexagonal autoblocante		159	A2912
Abrazadera M8 + M10 con taco y tirafondo Dowell.		153	A5108	Arandela plana		159	A2920
Abrazadera sin fin		153	A1600	Arpón espiga		159	A2740E
Abrazadera M8 de acero inoxidable AISI 304 con taco y tirafondo dowell		154	A1409B	Arpón gancho		159	A2740G
Abrazadera M8 Hydra 8000 blanca con taco y tirafondo Dowell M8 x 120		154	A5705	Cabeza arpón		159	A2700CA
Abarcon acero inoxidable AISI 304		154	A1430	Fijación de sanitario. Tipo C		160	A2500C
Abrazadera múltiple Hydra 1000		155	A1329	Fijación de sanitario. Tipo D		160	A2500D
Clip M6 nylon		155	A1311	Fijación WC horizontal. Tipo E		160	A2500E
Clip doble M6 nylon		155	A1312	Fijación de sanitario. Tipo A		160	A2500A
Taco de plástico dos cortes		156	A2215	Tubo aluminio flexible		161	A5100
Taco Ecoplus		156	A2226	Arandela mixta redonda		161	A8300
Tirafondo abrazadera con taco		156	A210A	Apoyaondas		161	A8600
Taco + Tornillo hexagonal para fachadas		156	A9430	Tornillo punta broca con arandela		161	A9210
Tirafondo abrazadera		157	A2100	Tornillo autorroscante con arandela		161	A9500
Tirafondo doble rosca Dowell		157	A2103	Kit 3 metros canal modelo HSB 100/50 + reja metálica pasarela clase A15		162	A3867
Anclaje hembra		157	A9200	Kit 3 metros canal modelo HSB 100/100 + reja metálica pasarela clase A15		162	A3867
Taco latón		157	A9250	Kit 3 metros canal HS 100/50 + reja plástico negro		163	A3860K3M2
Manguito hexagonal		158	A2300	Kit 3 metros canal HS 100/50 + reja metálica pasarela clase A15		163	A3860K3M1
Espárrago		158	A2311	Kit 3 metros canal HS 100/50 + reja fundición clase C250		163	A3860K3M9

Denominación	Foto	Pág.	Ref.
Rejilla de plástico. Tipo A		164	A3500A
Rejilla de plástico. Tipo H		164	A3500H
Rejilla de plástico. Tipo I		164	A3500I
Rejilla de plástico. Tipo J		164	A3500J
Rejilla de plástico. Tipo M (con red)		164	A3500M
Rejillas metálicas con colgador 15x15		165	A3120
Rejillas metálicas con colgador 16x16 Empotrar		165	A3120
Rejillas metálicas con colgador 17x17 empotrar		165	A3120
Rejillas metálicas con colgador 20x20		165	A3120
Rejillas metálicas con colgador 20x20 empotrar		165	A3120
Rejillas metálicas con colgador 30x15		165	A3120
Rejillas metálicas con colgador 30x30		165	A3120
Rejillas metálicas con mosquitera y colgador 15x15		166	A3121
Rejillas metálicas con mosquitera y colgador 17x17		166	A3121
Rejillas metálicas con mosquitera y colgador 20x20		166	A3121

017	ABRAZADERAS METÁLICAS REFORZADAS
030	ABRAZADERAS METÁLICAS LIGERAS
037	ABRAZADERAS DE PLÁSTICO
042	ACCESORIOS DE MONTAJE
055	ANCLAJES
059	TACOS DE PLÁSTICO Y BRIDAS
065	ABRAZADERAS Y ACCESORIOS EN ACERO INOXIDABLE
072	SOPORTACIÓN
080	INTUMESCENTE
087	VENTILACIÓN
094	DEFLECTORES Y TUBO FLEXIBLE DE ALUMINIO
099	CANALES DE DRENAJE
115	SOPORTES DE CANALÓN
120	FIJACIÓN DE CUBIERTA
124	FUNDICIÓN DE ALUMINIO
127	TAPAS Y PUERTAS DE CONTADOR
132	FUNDICIÓN DE HIERRO
137	EVACUACIÓN DE AGUA EN PLÁSTICO
144	COMPLEMENTOS
150	AUTOSERVICIO

Abrazaderas metálicas reforzadas



Ref. 1511 | Pág. 18



Ref. 1401 | Pág. 19



Ref. B1401 | Pág. 20



Ref. B1511 | Pág. 20



Ref. 1510D | Pág. 21



Ref. 1400D | Pág. 21



Ref. 1513 | Pág. 22



Ref. 1514 | Pág. 22



Ref. 1800 | Pág. 23



Ref. 5705AB | Pág. 23



Ref. 1940 | Pág. 24



Ref. 1960 | Pág. 24



Ref. 14702 | Pág. 24



Ref. 1710 | Pág. 25



Ref. 1730 | Pág. 25



Ref. 1700 | Pág. 25



Ref. 1750 | Pág. 26



Ref. 1407 | Pág. 26



Ref. 1407H | Pág. 26



Ref. 1420 | Pág. 27



Ref. B1610 | Pág. 28



Ref. 1610 | Pág. 28



Ref. 1414 | Pág. 29



Ref. 1422 | Pág. 29



Ref. 1422 | Pág. 29

ABRAZADERA ISOFÓNICA M8 + M10 HYDRAMIX

M8 + M10 HYDRAMIX CLAMP WITH EPDM RUBBER

Pincha QR para ver ficha técnica.



Tornillos laterales M6.

M6 side screws.

Desde Ø15-Ø60 fleje hasta 1,5 x 20mm.

Desde Ø75-Ø110 fleje hasta 2 x 20mm.

Desde Ø115-Ø315 fleje hasta 2,5 x 20mm.

From Ø15-Ø60 thickness 1,5 x 20mm.

From Ø75-Ø110 thickness 2 x 20mm.

From Ø115-Ø315 thickness 2 x 20mm.

**REDUCCION DE SONIDO
DIN 4109**

Sound reduction DIN 4109



Tornillos laterales M6.

M6 side screws.

Desde Ø350-Ø500 fleje hasta 2 x 28mm.

Desde Ø560-Ø710 fleje hasta 2,5 x 28mm.

From Ø350-Ø500 thickness 2 x 28mm.

From Ø560-Ø710 thickness 2,5 x 28mm.



Tornillos imperdibles
Safety screws



Acero cincado
Zinc plated



Caucho
Rubber



Reducción de sonido segun
DIN 4109
Sound reduction DIN 4109



Cobre
Copper



Acero
Steel



Plástico
Plastic



Chapa
Galvanized
sheet

Disponible en Acero Inox.
Consultar medidas en p.66-68
Available in stainless steel.
See measures on p.66-68

Disponible en Autoservicio p.152.
Available in self-service p.152.

Ref. 1511

Referencia	Ø (mm)	Min-Máx.					€ u.	
1511015	15	15-18	15	1/4		50	200	0,900
1511018	18	15-20	18	3/8		50	200	0,902
1511022	22	20-25	22	1/2	25	50	200	0,990
1511028	28	26-32	28	3/4		50	200	1,091
1511035	35	32-36	35	1"	32	50	200	1,166
1511040	40-42	38-43	42	1" 1/4	40	50	200	1,265
1511048	48-50	47-51		1" 1/2	50	25	100	1,416
1511054	54	53-58	54			25	100	1,499
1511060	60	60-64	63	2"	63	25	50	1,588
1511075	75	75-80	76	2" 1/2	75	-	50	1,805
1511083	83	81-85				-	50	1,925
1511090	90	87-92	89	3"	90	-	50	1,966
1511100	100	99-105		3" 1/2	100	-	50	2,170
1511110	110	107-112	108		110	-	50	2,522
1511115	115	113-116		4"		-	50	2,709
1511125	125	122-127			125	-	50	2,881
1511140	140	137-142		5"	140	-	50	3,302
1511150	150	144-153				-	50	3,425
1511160	160	157-162			160	-	40	3,729
1511200	200	198-202			200	-	40	4,519
1511220	220	219-224		8"		-	40	5,221
1511250	250	248-252			250	-	25	5,717
1511300	300	297-302			300	-	25	7,036
1511315	315	312-317			315	-	25	7,531

Referencia	Ø (mm)	Min-Máx.					€ u.	
1511350	350	347-355				-	25	13,229
1511400	400	399-406				-	25	21,485
1511450	450	449-456				-	25	23,740
1511500	500	499-506				-	25	25,669
1511560	560	559-566				-	25	31,550
1511600	600	599-606				-	25	33,764
1511630	630	629-636				-	25	35,346
1511710	710	709-716				-	25	39,082

ABRAZADERA M8 + M10 HYDRAMIX

M8 + M10 HYDRAMIX CLAMP

Pincha QR para ver ficha técnica.



Tornillos laterales M6.
M6 side screws.
Desde Ø15-Ø115 fleje hasta 2 x 20mm.
Desde Ø120-Ø315 fleje hasta 2,5 x 20mm.
From Ø15-Ø115 thickness 2 x 20mm.
From Ø120-Ø315 thickness 2,5 x 20mm.

* Hasta final de existencias. / Until end of stocks.

Ref. 1401

Referencia	Ø (mm)	Min-Máx.		P"				€ u.
1401015	15	12-17	15	1/4		50	200	0,782
1401018	18	15-19	18	3/8		50	200	0,821
1401022	22	20-25	22	1/2	25	50	200	0,863
1401026	26	26-30	28	3/4		50	200	0,921
1401035	35	32-36	35	1"	32	50	200	0,981
1401040	40	38-43	42	1" 1/4	40	50	200	1,079
1401048	48	47-51		1" 1/2	50	25	100	1,213
1401054	54	53-57	54			25	100	1,271
* 1401059	60	60		2"		25	50	1,006
1401060	60	60-64	63	2"	63	25	50	1,341
1401075	75	75-80	76	2" 1/2	75	-	50	1,362
1401083	83	81-85				-	50	1,434
1401090	90	87-92	89	3"	90	-	50	1,498
1401100	100	99-105		3" 1/2	100	-	50	1,623
1401110	110	107-112	108		110	-	50	1,703
1401115	115	113-116		4"		-	50	2,043
1401120	120	118-123				-	50	2,162
1401125	125	122-127			125	-	50	2,233
1401140	140	137-142		5"	140	-	50	2,722
1401150	150	148-152				-	50	2,772
1401160	160	157-162			160	-	40	2,891
1401175	175	173-177				-	40	3,110
1401200	200	198-202			200	-	40	3,593
1401220	220	218-224		8"		-	40	4,338
1401250	250	248-252			250	-	25	4,544
1401300	300	297-302				-	25	6,054
1401315	315	312-317			315	-	25	6,272
1401350	350	349-354				-	25	9,074



Tornillos laterales M6.
M6 side screws.
Desde Ø350-Ø500 fleje hasta 2 x 28mm.
Desde Ø560-Ø1250 fleje hasta 2,5 x 28mm.
From Ø350-Ø500 thickness 2 x 28mm.
From Ø560-Ø1250 thickness 2,5 x 28mm.

Referencia	Ø (mm)	Min-Máx.		P"				€ u.
1401400	400	399-406				-	25	10,261
1401450	450	449-456				-	25	12,611
1401500	500	499-506				-	25	14,360
1401560	560	559-568				-	25	16,176
1401600	600	599-608				-	25	17,233
1401630	630	629-636				-	25	17,857
1401650	650	649-656				-	25	18,732
1401700	700	699-706				-	25	19,606
1401800	800	799-806				-	25	22,150
1401900	900	899-906				-	25	28,508
14011000	1000	999-1006				-	25	34,443
14011100	1100	1099-1106				-	25	44,299
14011200	1200	1199-1206				-	25	46,366
14011250	1250	1249-1256				-	25	47,123

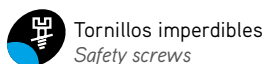

Disponible en Acero Inox p. 66-68.
Available in stainless steel p. 66-68.

Disponible en Autoservicio p. 152-153.
Available in self-service p. 152-153.

ABRAZADERA M8 + M10 HYDRAMIX ETIQUETADO INDIVIDUAL

M8 + M10 HYDRAMIX CLAMP



NOVEDAD
New

Ref. B1401

Referencia	Ø (mm)	Min-Máx.						€ u.
B1401040	40	38-43	42	1" 1/4	40	50	200	1,229
B1401048	48	47-51		1" 1/2	50	25	100	1,363
B1401060	60	60-64	63	2"	63	25	50	1,491
B1401075	75	75-80	76	2" 1/2	75	-	50	1,512
B1401090	90	87-92	89	3"	90	-	50	1,648
B1401110	110	107-112	108		110	-	50	1,853
B1401125	125	122-127			125	-	50	2,383
B1401160	160	157-162			160	-	40	3,041
B1401200	200	198-202			200	-	40	3,743

Tornillos laterales M6.

M6 side screws.

Desde Ø40-Ø110 fleje hasta 2 x 20mm.

Desde Ø125-Ø200 fleje hasta 2,5 x 20mm.

From Ø40-Ø110 thickness 2 x 20mm.

From Ø125-Ø200 thickness 2,5 x 20mm.

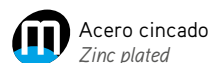

ABRAZADERA ISOFÓNICA M8 + M10 HYDRAMIX ETIQUETADO INDIVIDUAL

M8 + M10 HYDRAMIX CLAMP WITH EPDM RUBBER



NOVEDAD
New

Ref. B1511

Referencia	Ø (mm)	Min-Máx.						€ u.
B1511035	35	32-36	35	1"	32	50	200	1,316
B1511040	40-42	38-43	42	1" 1/4	40	50	200	1,415
B1511048	48-50	47-51		1" 1/2	50	25	100	1,566
B1511060	60	60-64	63	2"	63	25	50	1,738
B1511075	75	75-80	76	2" 1/2	75	-	50	1,955
B1511090	90	87-92	89	3"	90	-	50	2,116
B1511110	110	107-112	108		110	-	50	2,672
B1511125	125	122-127			125	-	50	3,031

Tornillos laterales M6.

M6 side screws.

Desde Ø35-Ø60 fleje hasta 1,5 x 20mm.

Desde Ø75-Ø110 fleje hasta 2 x 20mm.

Ø125 fleje hasta 2,5 x 20mm.

From Ø35-Ø60 thickness 1,5 x 20mm.

From Ø75-Ø110 thickness 2 x 20mm.

Ø125 thickness 2 x 20mm.

REDUCCION DE SONIDO
DIN 4109
Sound reduction DIN 4109

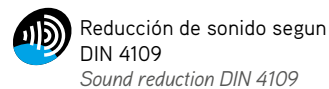
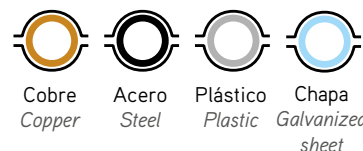

ABRAZADERA ISOFÓNICA M8 + M10 HYDRASOL "D"

M8 + M10 HYDRASOL "D" CLAMP WITH EPDM RUBBER

Ref. 1510D

Pincha QR para ver ficha técnica.



REFORZADO ESPECIAL
Special weld



Dacromet + Caucho EPDM
Dacromet + EPDM Rubber



Soldadura por cordón
Cord welding



Cobre Acero Plástico
Copper Steel Plastic

Referencia	Ø (mm)	Min-Máx.			P"			€ u.
1510D022	22	20-25	22	1/2			50	2,611
1510D028	26-28	26-30	28	3/4			50	2,853
1510D035	35	32-36	35	1"		32	50	3,117
1510D040	40	38-43	42	1" 1/4		40	50	3,419
1510D048	48	47-51		1" 1/2		50	25	3,604
1510D054	54	53-58	54				25	5,133
1510D060	60	60-64	63	2"		63	25	5,432
1510D075	75	75-80	76	2" 1/2		75	25	6,272
1510D090	90	87-92	89	3"		90	25	7,083
1510D110	110	107-112	108			110	25	8,152
1510D115	115	113-118		4"			25	8,484
1510D125	125	123-128				125	25	9,171
1510D140	140	138-143		5"		140	25	11,783
1510D160	160	158-163				160	25	13,152
1510D200	200	198-203				200	20	15,843
1510D220	220	218-223					20	16,743
1510D250	250	248-251				250	20	18,475



Dacromet | Resistente a ambientes corrosivos
Dacromet | Resistant to corrosive environments



Caucho
Rubber



Tornillos imperdibles
Safety screws



Reducción de sonido
Sound reduction



Máxima fiabilidad
Maximum reliability

Desde Ø15-Ø48 fleje hasta 1.5 x 25mm.
Desde Ø54-Ø250 fleje hasta 2.5 x 25mm.
Tornillos laterales M6.

From Ø15-Ø48 thickness 1.5 x 25mm.
From Ø54-Ø250 thickness 2.5 x 25mm.
M6 side screws.

MAS RESISTENTE AL OXIDO
More oxide resistant

ABRAZADERA M8 + M10 HYDRASOL "D"

M8 + M10 HYDRASOL "D" CLAMP

Ref. 1400D

Pincha QR para ver ficha técnica.



REFORZADO ESPECIAL
Special weld



Soldadura por cordón
Cord welding



Cobre Acero Plástico
Copper Steel Plastic

Referencia	Ø (mm)	Min-Máx.			P"			€ u.
1400D022	22	20-25	22	1/2			50	2,223
1400D026	26	26-29	28	3/4			50	2,284
1400D035	35	32-36	35	1"		32	50	2,468
1400D040	40	38-43	42	1" 1/4		40	50	2,629
1400D048	48	47-51		1" 1/2		50	25	2,919
1400D060	60	60-64	63	2"		63	25	4,241
1400D075	75	75-80	78	2" 1/2		75	25	4,848
1400D090	90	87-92	89	3"		90	25	5,272
1400D100	100	97-101		3" 1/2		100	25	5,736
1400D110	110	107-112	108			110	25	6,120
1400D115	115	113-118		4"			25	7,093
1400D125	125	123-128				125	25	7,508
1400D140	140	138-143				140	25	8,393
1400D160	160	158-163				160	25	9,225
1400D200	200	198-203				200	20	11,958
1400D250	250	248-251				250	20	14,290



Dacromet | Resistente a ambientes corrosivos
Dacromet | Resistant to corrosive environments



Tornillos imperdibles
Safety screws



Máxima fiabilidad
Maximum reliability

Desde Ø15-Ø48 fleje hasta 1.5 x 25mm.
Desde Ø60-Ø250 fleje hasta 2.5 x 25mm.
Tornillos laterales M6.

From Ø15-Ø48 thickness 1.5 x 25mm.
From Ø60-Ø250 thickness 2.5 x 25mm.
M6 side screws.

MAS RESISTENTE AL OXIDO
More oxide resistant

ABRAZADERA HYDRADES ISOFÓNICA M8+M10 1T

M8+M10 HYDRADRES 1T TYPE CLAMP WITH EPDM RUBBER



Pincha QR para ver ficha técnica.



DESLIZANTE
Sliding



Plástico PPR
PPR Plastic



Acero cincado
Zinc plated



Reducción de sonido (DIN 4109)
Sound reduction (DIN 4109)



Caucho
Rubber



Rápida instalación
Easy installation

Desde Ø16-Ø40 fleje de 1.2 x 20.
Desde Ø50 fleje hasta 1.5 x 20.
Tornillos laterales M5.

From Ø16-Ø40 thickness 1.2 x 20mm.
Ø50 thickness 1.5 x 20mm.
M5 side screws.

Ref. 1513

Referencia	Ø (mm)	Min-Máx.		P"			€ u.
1513016	16	16	16		15	50	1,590
1513020	20	20-22	22	1/2	20	50	1,778
1513025	25	25-26		3/4	25	50	1,957
1513032	32	32			32	50	2,323
1513040	40	40-42	42	1" 1/4	40	50	2,558
1513050	50	48-50		1" 1/2	50	25	3,296



Pincha QR para ver ficha técnica.



DESLIZANTE
Sliding



Plástico PPR
PPR Plastic



Acero cincado
Zinc plated



Caucho
Rubber



Reducción de sonido (DIN 4109)
Sound reduction (DIN 4109)



Rápida instalación
Easy installation

Desde Ø63-Ø90 fleje de 1.5 x 20.
Desde Ø110-Ø160 fleje hasta 2 x 20.
Tornillos laterales M6.

From Ø63-Ø90 thickness 1.5 x 20mm.
From Ø110-Ø160 thickness 2 x 20mm.
M6 side screws.

Ref. 1514

Referencia	Ø (mm)	Min-Máx.		P"			€ u.
1514063	63	60-64	63	2"	63	25	4,476
1514075	75	75	76	2" 1/2	75	25	4,771
1514090	90	90	89	3"	90	25	5,048
1514110	110	110	108		110	25	7,341
1514125	125	125			125	25	7,722
1514160	160	160			160	25	10,095

ABRAZADERA M8 HYDRA 8000

M8 HYDRA 8000 CLAMP

Pincha QR para ver ficha técnica.



Modelo patentado
Patented model



Disponible en Autoservicio p. 153.
Available in self-service p. 153.

Tornillos laterales
y tuercas imperdibles M6
Safety screws & nuts M6



Acero galvanizado
Galvanized steel



Tornillos imperdibles
Safety screws



Plástico
Plastic

Ref. 1800

Referencia	Ø (mm)			€ u.
1800050	50	50	50	2,148
1800063	63	63	50	2,197
1800075	75	75	50	2,209
1800080	80	80	50	2,263
1800090	90	90	50	2,199
1800100	100	100	50	2,492
1800110	110	110	50	2,175
1800125	125	125	50	2,304
* 1800130	130	-	50	2,891
1800160	160	160	50	3,380
1800200	200	200	50	4,206
1800250	250	250	25	7,511
1800315	315	315	25	10,300

* Hasta final de existencias. / Until end of stocks.

Desde Ø50-Ø160 fleje hasta 0.8 x 26mm.

Ø200 fleje hasta 1 x 26mm.

Ø250 fleje hasta 1.5 x 26mm.

Ø315 fleje hasta 2 x 26mm.

From Ø50-Ø160 thickness 0.8 x 26mm.

Ø200 thickness 1 x 26mm.

Ø250 thickness 1.5 x 26mm.

Ø315 thickness 2 x 26mm.

ABRAZADERA M8 HYDRA 8000 BLANCA

WHITE M8 HYDRA 8000 CLAMP

Pincha QR para ver ficha técnica.



Modelo patentado
Patented model



Tornillos laterales
y tuercas imperdibles M6
Safety screws & nuts M6



Acero con pintura epoxi blanca
White epoxy painted steel



Aluminio y chapa blanco
White aluminium



Tornillos imperdibles
Safety screws

Ref. 5705AB

Referencia	Ø (mm)			€ u.
5705AB080	80	80	25	4,715
5705AB100	100	100	25	5,254
5705AB110	110	110	25	5,533
5705AB125	125	125	25	5,980
5705AB130	130	130	25	6,012

Disponible en Autoservicio p. 154.

Available in self-service p. 154.

Especialmente indicado para el tubo de aluminio blanco o chapa blanca.

Clamps for white lacquered aluminium pipe.

TORNILLO CARRIL M6 X 10

M6 RAIL SCREW M6 X 10'



Acero cincado
Zinc plated

Especial montantes para guías 25 x 75 x 0,8 y 20 x 10 x 1.
Screws for rails 25 x 75 x 0,8 and 20 x 10 x 1.

* Ref. 1940

Referencia	R / L		€ u.
1940610	M-6 x 10	500	0,093

* Hasta final de existencias. / Until end of stocks.

SOPORTE ISOFÓNICO

SUPPORT WITH RUBBER



* Ref. 1960

Referencia	Nº taladros		€ u.
196004	4	25	1,655
196007	7	25	2,263

* Hasta final de existencias. / Until end of stocks.

Acero cincado
Zinc plated

Caucho
Rubber

Para el cálculo, tomar como base el nº de taladros indicado por grapas, y para las siguientes restar uno, pues al montar una pata sobre la otra se utiliza el mismo taladro y el mismo tornillo.

Ejemplo: 6 tubos Ø 22 = (1x3) + (5x2) = 13 Taladros.

Calculation: Take as base the number of holes shown per clips. Subtract one for following measures because you use the same hole and the same screw when mounting one clip over another.

Example: 6 tubes Ø 22 = (1x3) + (5x2) = 13 holes.

ABRAZADERA HCV HOMOLOGACIÓN FM

HANGER CLAMP FM APPROVED



Ref. 14702

Pincha QR para ver ficha técnica.



Referencia	P"	R		€ u.
14702022	1/2	M-10	100	0,864
14702026	3/4	M-10	100	0,879
14702035	1"	M-10	100	0,931
14702042	1" 1/4	M-10	100	1,018
14702048	1" 1/2	M-10	100	1,120
14702060	2"	M-10	100	1,188
14702075	2" 1/2	M-10	100	1,425
14702090	3"	M-10	100	1,568
14702115	4"	M-10	100	2,502
14702140	5"	M-12	100	4,742
14702160	6"	M-12	100	6,370

Acero
Steel

Acero cincado
Zinc plated

Para instalaciones suspendidas aunque tengan difusores en la parte superior.
For suspended facilities although they have diffusers on top side.

ABRAZADERA EMPOTRAR PVC REFORZADA

HEAVY "Y" TYPE CLAMP



Ref. 1710 Pincha QR para ver ficha técnica.



Referencia	Ø (mm)		P"		€ u.
1710075	75	75	2" 1/2	100	1,908
1710090	90	90	3"	100	1,950
1710110	110	110		100	2,200
1710125	125	125		50	2,400
1710160	160	160		50	3,000
1710200	200	200		30	3,325
1710250	250	250		25	6,268
1710315	315	315		25	7,975

Acero cincado
Zinc plated

Acero
Steel Plástico
Plastic

ABRAZADERA TIPO "U"

"U" TYPE CLAMP



* Ref. 1730

Referencia	Ø (mm)		P"		€ u.
1730050	50	50	1" 1/2	100	1,000
1730075	75	75	2" 1/2	90	2,102
1730090	90	90	3"	100	2,149
1730160	160	160		20	3,303
1730200	200	200		10	3,664
1730250	250	250		25	6,907

* Hasta final de existencias. / Until end of stocks.

Acero cincado
Zinc plated

Acero
Steel Plástico
Plastic

ABRAZADERA EMPOTRAR PVC HYDRA 7000

LIGHT "U" TYPE CLAMP

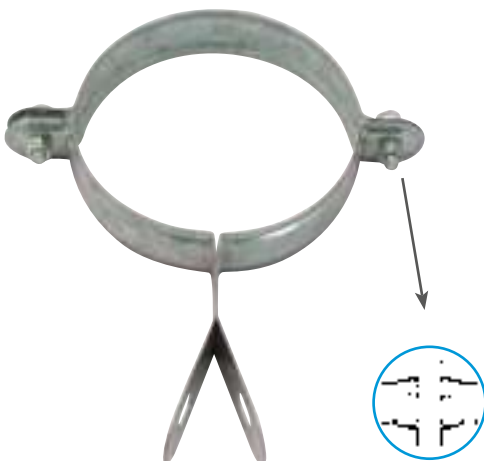

* Ref. 1700

Referencia	Ø (mm)		P"		€ u.
1700075	75	75	2" 1/2	25	1,150
1700090	90	90	3"	25	1,260
1700110	110	110		50	1,440
1700125	125	125		25	1,560

* Hasta final de existencias. / Until end of stocks.

Acero cincado
Zinc plated

Tornillos imperdibles
Safety screws

Plástico
Plastic

Tornillos laterales y tuercas imperdibles M6
Safety screws & nuts M6

ABRAZADERA REGULABLE

ADJUSTABLE CLAMP BIG DIAMETER PIPE

* Ref. 1750

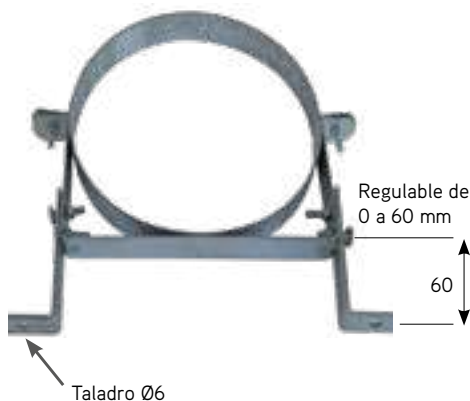

Referencia	Ø (mm)	Min-Máx	Fleje			€ u.
1750200	200	198-205	2 x 30	200	1	8,425
1750250	250	249-254	2 x 30	250	1	13,484
1750300	300	299-304	2 x 30	300	1	16,855
1750400	400	399-404	3 x 30	400	1	37,625

* Hasta final de existencias. / Until end of stocks.

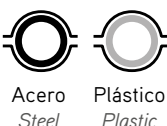

ABRAZADERA M8 CTA AMARILLA

M8 CTA YELLOW PAINTED CLAMP

Ref. 1407

Pincha QR para ver ficha técnica.



Pintada
Painted

Referencia	Ø (mm)	Min-Máx			P"	€ u.
140718	18	16-20	18	3/8	50	1,314
140722	22	21-24	22	1/2	50	1,345
140726	26	25-28	28	3/4	50	1,403
140735	35	34-37	35	1"	50	1,496
140740	40-42	40-44	42	1" 1/4	50	1,610
140748	48	47-51		1" 1/2	25	1,791
140754	54	54-57	54	-	25	1,838

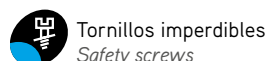
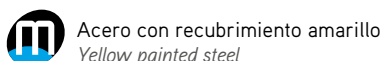
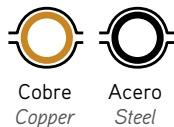

ABRAZADERA M8+M10 CTA AMARILLA

M8+M10 CTA YELLOW PAINTED CLAMP

Ref. 1407H

Pincha QR para ver ficha técnica.



Pintada
Painted

Referencia	Ø (mm)	Min-Máx			P"	€ u.
1407H60	60	59-64	63	2"	25	2,130
1407H75	75	74-80	76	2" 1/2	25	2,285
1407H90	90	89-94	89	3"	25	2,469
1407H115	115	113-116		4"	25	3,177

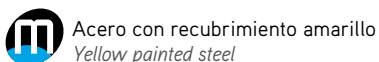
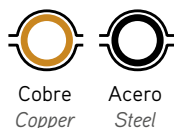

ABARCÓN

U-BOLT

Ref. 1420

Pincha QR para ver ficha técnica.

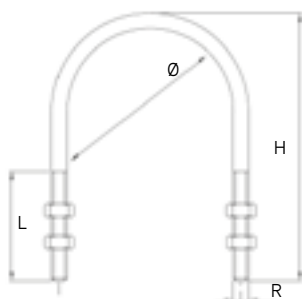

Referencia	Ø P"	Ø (mm)	L (mm)	H	R		€ u.
*1420015	1/4	15,2	15	34	M6	100	0,477
*1420018	3/8	18,2	22	43	M6	100	0,491
1420022	1/2	22,5	22	46	M6	100	0,526
1420026	3/4	28,5	30	55	M6	100	0,580
1420035	1"	35,8	34	62	M6	50	0,631
1420042	1" 1/4	44,5	34	74	M6	50	0,695
1420048	1" 1/2	49,5	34	80	M8	30	1,312
1420060	2"	62	38	90	M8	30	1,426
*1420070	2" 1/4	72,5	42	107	M8	20	1,474
1420075	2" 1/2	78	48	115	M8	20	1,949
1420090	3"	93	48	120	M8	20	2,098
1420100	3" 1/2	104	54	152	M8	20	2,450
1420115	4"	117	52	160	M8	20	2,746
*1420115M10	4"	117	52	160	M10	20	3,181
1420140	5"	141	40	183	M10	10	4,712
1420160	6"	174	40	215	M10	10	5,336

* Hasta final de existencias. / Until end of stocks.

Equipado con cuatro tuercas.
Available with four nuts.

Acero cincado
Zinc plated

Acero
Steel

Ref. 1420

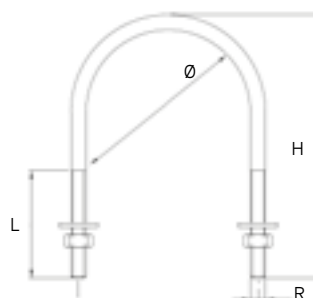

Referencia	Ø P"	Ø (mm)	L (mm)	H	R		€ u.
1420220	8"	232	40	264	M10	1	7,448
1420250	10"	286	40	318	M10	1	8,757
1420300	12"	339	50	378	M14	1	28,421
1420350	14"	372	50	410	M14	1	40,265
1420400	16"	422	60	470	M14	1	43,508
1420450	18"	476	70	532	M16	1	60,218
1420500	20"	529	70	585	M16	1	68,307

Equipado con dos tuercas y dos arandelas.
Available with two nuts and two washes.

Acero cincado
Zinc plated

Acero
Steel

Debido a nuestro proceso de mejora continua las dimensiones pueden variar ligeramente. Si tienen interés, consulte los datos en el momento de la compra.

Due to our continuous improvement process, dimensions may vary please check the information before the purchase.

Disponible en Acero Inox p. 67.
Available in stainless steel p. 67.

Disponible en Autoservicio p. 154.
Available in self-service p. 154.

ABRAZADERA SUPER

SUPER CLAMP

Pincha QR para ver ficha técnica.



Ref. B1610 ETIQUETADO INDIVIDUAL

Referencia	Ø (mm)		€ u.
B1610023	23-25	50	2,364
B1610026	26-28	50	2,413
B1610029	29-31	50	2,420
B1610032	32-35	50	2,466
B1610036	36-39	50	2,501
B1610040	40-43	50	2,533
B1610044	44-47	50	3,972
B1610048	48-51	50	4,028
B1610052	52-55	50	4,070
B1610056	56-59	50	4,132
B1610060	60-63	50	4,209
B1610064	64-67	50	4,629
B1610068	68-73	50	5,549
B1610074	74-79	50	5,744



Ref. 1610

Referencia	Ø (mm)		€ u.
1610080	80-85	50	5,812
1610086	86-91	50	6,051
1610092	92-97	50	6,076
1610098	98-103	50	6,193
1610104	104-112	50	6,405
1610113	113-121	50	6,821
1610122	122-130	25	7,026
1610131	131-139	25	18,727
1610140	140-148	25	19,168
1610149	149-161	25	20,508
1610162	162-174	25	21,773
1610175	175-187	15	22,425
1610188	188-200	15	23,048
1610201	201-213	15	26,454
1610214	214-226	10	27,094
1610227	227-239	10	28,294
1610240	240-252	10	28,962

Medidas (mm)

Desde	Hasta	Ancho de banda / R
23-25	40-43	20 mm / M6 ⁽¹⁾
44-47	122-130	23 mm / M8 ⁽²⁾
131-139	240-252	30 mm / M10 ⁽³⁾



Con tres puntos de soldadura.
With three points of welding.

⁽¹⁾ Ancho: 20. Espesor: 0,8mm.

⁽²⁾ Ancho: 23. Espesor: 1,2mm.

⁽³⁾ Ancho: 30. Espesor: 1,7mm.

ABRAZADERA ISOFÓNICA M8 HYDRALIG

M8 HYDRALIG CLAMP WITH EPDM RUBBER

Pincha QR para ver ficha técnica.



Tornillos imperdibles
Safety screws

Acero cincado
Zinc plated

Caucho
Rubber

Reducción de sonido
Sound reduction

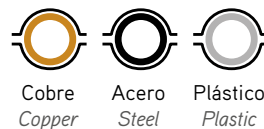

Cincado + Caucho EPDM
Zinc plated + EPDM Rubber

Ref. 1414

Referencia	Ø (mm)	Min-Máx.		P"			€ u.
1414015	15	15-17	15	1/8		50	0,676
1414018	18	18	18	3/8		50	0,687
1414022	22	22	22	1/2	25	50	0,723
1414026	26	26-28	28	3/4		50	0,799
1414035	35	35	35	1"	32	50	0,878
1414040	40	40-42	42	1" 1/4	40	50	1,117
1414048	48	48-50		1" 1/2	50	50	1,133
1414054	54	52-56	54			50	1,373
1414060	60	60	63	2"	63	50	1,471

Desde Ø15-Ø48 fleje hasta 1 x 20mm.
Tornillos laterales M5.

From Ø15-Ø48 thickness 1 x 20mm.
M5 side screws.

Desde Ø54-Ø60 fleje hasta 1.2 x 20mm.
Tornillos laterales M6.

From Ø350-Ø500 thickness 1.2 x 20mm.
M6 side screws.

SOPORTES ABARCÓN

U-BOLT SUPPORT

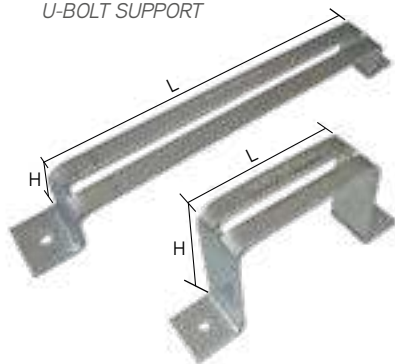

* Ref. 1422

Referencia	H	L		€ u.
1422050300	50	300	5	6,274
1422100200	100	200	5	6,404
1422100300	100	300	5	8,365
1422100400	100	400	5	11,190

* Hasta final de existencias. / Until end of stocks.

Acero cincado
Zinc plated

Abrazaderas metálicas ligeras



Ref. 1100 | Pág. 31



Ref. 1120 | Pág. 31

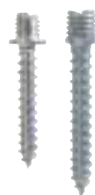

Ref. 2100 | Pág. 31



Ref. 1107 | Pág. 32



Ref. 1108 | Pág. 32



Ref. 1110 | Pág. 33



Ref. 1220 | Pág. 33



Ref. 1101 | Pág. 33



Ref. 1103 | Pág. 34



Ref. 1215 | Pág. 34



Ref. 2102 | Pág. 34



Ref. 1620 | Pág. 34



Ref. 1600 | Pág. 35



Ref. B1600 | Pág. 35



Ref. 2110 | Pág. 35



Ref. 1910 | Pág. 36



Ref. 1920 | Pág. 36

ABRAZADERA M6

M6 CLAMP

Ref. 1100

Pincha QR para ver ficha técnica.



Acero bicromatado
Yellow zinc plated

Apertura lateral
Lateral opening

Cobre
Copper

Acero
Steel

Plástico
Plastic

Referencia	Ø (mm)		P"		€ u.	
110008	8	8		100	0,257	
110010	10	10	1/8	100	0,258	
110012	12	12	1/4	100	0,259	
110014	14	14		100	0,263	
110015	15	15		100	0,268	
110016	16	16		16	100	0,279
110018	18	18	3/8	100	0,286	
110020	20	22	1/2	20	100	0,296
110024	24			100	0,316	
110025	25			25	100	0,324
110026	26		3/4	100	0,328	
110028	28	28		100	0,337	
*110030	30			50	0,361	
110032	32		1"	32	50	0,382
110035	35	35		50	0,440	
110038	38			50	0,451	
110040	40			40	50	0,467
110042	42	42	1" 1/4	42	50	0,483
110047	47		1" 1/2	50	0,574	
110050	50			50	50	0,589
110054	54	54		50	0,708	
110060	60		2"	60	50	0,773
110063	63			63	50	0,800

Disponible en Autoservicio p. 151.
Available in self-service p. 151.

* Hasta final de existencias. / Until end of stocks.

ABRAZADERA DOBLE M6

M6 DOUBLE CLAMP

Ref. 1120

Pincha QR para ver ficha técnica.



Cobre
Copper

Acero
Steel

Plástico
Plastic

Referencia	Ø (mm)		P"		€ u.
112012	12	12	1/4	100	0,425
112014	14	14		100	0,454
112015	15	15		100	0,472
112018	18	18	3/8	100	0,523
112022	22	22	1/2	50	0,592
112028	28	28	3/4	25	0,684

Acero bicromatado
Yellow zinc plated

Disponible en Autoservicio p. 151.
Available in self-service p. 151.

TIRAFONDO ABRAZADERA

CONNECTING SCREW

Ref. 2100

Pincha QR para ver ficha técnica.

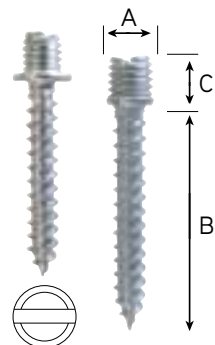

Acero cincado
Zinc plated

Disponible en Acero Inox p. 69.
Available in stainless steel p. 69.

Disponible en Autoservicio p. 157.
Available in self-service p. 157.

Referencia	A x B x C (mm)		€ u.
2100630	M6 x 30 x 6	100	0,103
2100640	M6 x 40 x 6	100	0,140
2100650	M6 x 50 x 6	100	0,199
2100840	M8 x 40 x 7	100	0,282
2100860	M8 x 60 x 7	100	0,513
21001050	M10 x 50 x 10	100	0,743

ABRAZADERA ISOFÓNICA M6 G/E

M6 CLAMP WITH RUBBER

Pincha QR para ver ficha técnica.



Ref. 1107



Acero bicromatado
Yellow zinc plated



Apertura lateral
Lateral opening



Cobre Acero Plástico
Copper Steel Plastic



Caucho
Rubber



Tubo gas
Gas pipe



Reducción de sonido
Sound reduction

Disponible en Autoservicio p. 151.
Available in self-service p. 151.

Referencia	Ø (mm)					€ u.
110712	12	12	1/4		100	0,399
110715	15	15			100	0,456
110716	16	16		16	100	0,462
110718	18	18	3/8		100	0,479
110720	20			20	100	0,502
110722	22	22	1/2		100	0,521
110726	25-26		3/4	25	100	0,584
110728	28	28			100	0,604
110732	32			32	50	0,705
110735	35	35	1"		50	0,761
110740	40			40	50	0,984
110742	42	42	1" 1/4		50	0,996
110748	48		1" 1/2		50	1,200
110750	50			50	50	1,216
110754	54	54			50	1,341
110760	60		2"	60	50	1,401

ABRAZADERA ISOFÓNICA DOBLE M6 G/E

M6 DOUBLE CLAMP WITH RUBBER

Pincha QR para ver ficha técnica.



Ref. 1108

Referencia	Ø (mm)				€ u.
110812	12	12	1/4	100	0,773
110815	15	15		50	0,924
110818	18	18	3/8	50	0,983
110822	22	22	1/2	25	1,258
110828	28	28	3/4	25	1,567



Cobre
Copper



Acero
Steel



Plástico
Plastic



Caucho
Rubber



Acero bicromatado
Yellow zinc plated



Tubo gas
Gas pipe



Reducción de sonido
Sound reduction

Disponible en Autoservicio p. 151.
Available in self-service p. 151.

ABRAZADERA M6 CON TIRAFONDO

M6 CLAMP WITH CONNECTING SCREW

Pincha QR para ver ficha técnica.



Ref. 1110

Referencia	Ø (mm)			P"		€ u.
111010	10				100	0,415
111012	12	12		1/4	100	0,418
111015	15	15			100	0,441
111016	16	16			100	0,447
111018	18	18		3/8	100	0,456
111020	20	20			100	0,475
111022	22	22		1/2	100	0,501
111025	25	25			100	0,509
111026	26			3/4	100	0,523
111028	28	28			100	0,537
111032	32	32		1"	50	0,570
111035	35	35			50	0,653
111040	40	40			50	0,724
111042	42	42		1" 1/4	25	0,738
111050	50	50			25	0,848
111054	54				25	1,037
111063	63	63			25	1,048



Acero bicromatado
Yellow zinc plated



Apertura lateral
Lateral opening



Cobre
Copper



Acero
Steel



Plástico
Plastic

ABRAZADERA DOBLE M6 CON TIRAFONDO

M6 DOUBLE CLAMP WITH CONNECTING SCREW

Pincha QR para ver ficha técnica.



Ref. 1220

Referencia	Ø (mm)			P"		€ u.
122012	12	12		1/4	100	0,627
122015	15	15			100	0,690
122018	18	18		3/8	100	0,722
122022	22	22		1/2	50	0,816
122028	28	28		3/4	25	1,215



Cobre
Copper



Acero
Steel



Plástico
Plastic



Acero bicromatado
Yellow zinc plated

ABRAZADERA M6 CROMADA

M6 CHROME PLATED CLAMP

Pincha QR para ver ficha técnica.



Ref. 1101

Referencia	Ø (mm)			P"		€ u.
110110	10	10		1/8	100	0,336
110112	12	12		1/4	100	0,349



Tubo de cobre cromado
Chrome plated copper tube



Acero cromado
Chrome plated



Apertura lateral
Lateral opening



Tubo gas
Gas pipe

ABRAZADERA M6 CTF NEGRA CON TIRAFONDO

M6 BLACK PAINTED CLAMP WITH CONNECTING SCREW

Pincha QR para ver ficha técnica.



Ref. 1103

Referencia	Ø (mm)		P"		€ u.
110310	10	10	1/8	100	0,526
110312	12	12	1/4	100	0,528
110315	15	15		100	0,549
110318	18	18	3/8	100	0,570
110322	22	22	1/2	100	0,613
110328	28	28	3/4	100	0,651
110335	35	35	1"	50	0,798
110342	42	42	1" 1/4	50	0,882



Pintada
Painted

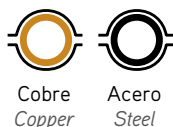

Cobre
Copper Acero
Steel

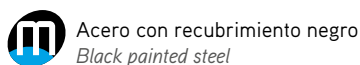

ABRAZADERA M6 CTA AMARILLA CON TIRAFONDO

M6 YELLOW PAINTED CLAMP WITH CONNECTING SCREW

Pincha QR para ver ficha técnica.



Ref. 1215

Referencia	Ø (mm)		P"		€ u.
121512	12	12	1/4	100	0,627
121515	15	15		100	0,652
121518	18	18	3/8	100	0,678
121522	22	22	1/2	100	0,730
121528	28	28	3/4	100	0,774
121535	35	35	1"	50	0,949



Pintada
Painted

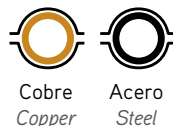

Cobre
Copper Acero
Steel

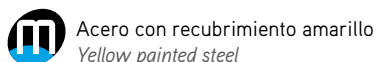

FLORÓN ABRAZADERA M6

WASHER FOR M6 CLAMP

Pincha QR para ver ficha técnica.



Ref. 2102

Referencia	D	M (mm)		€ u.
*2102F25	Plano	25	100	0,069
2102FS09	Separador	9	100	0,322
2102FS14	Separador	14	100	0,485
*2102FS19	Separador	19	100	0,814
*2102FS24	Separador	24	100	1,076

* Hasta final de existencias. / Until end of stocks.



ABRAZADERA BTN

BTN CLAMP

Pincha QR para ver ficha técnica.



Ref. 1620

Referencia	Ø (mm)		€ u.
162013	13-15	100	0,365
162015	15-18	100	0,375



Ancho de banda 9 mm. Tornillo rosca M 4.
Bandwidth 9 mm. Screw M4.

ABRAZADERA SIN FIN

GERMAN TYPE HOSE CLAMP

Pincha QR para ver ficha técnica.



Ref. 1600

Referencia	Ø (mm)		€ u.
1600008	8-16	200	0,415
1600012	12-22	200	0,434
1600016	16-27	200	0,452
1600020	20-32	200	0,470
1600025	25-40	100	0,524
1600032	32-50	50	0,561
1600040	40-60	50	0,655

Ref. B1600 - ETIQUETADO INDIVIDUAL

Referencia	Ø (mm)		€ u.
B1600050	50-70	50	0,757
B1600060	60-80	50	0,822
B1600070	70-90	50	0,881
B1600080	80-100	25	0,944
B1600090	90-110	25	1,103
B1600100	100-120	25	1,173
B1600110	110-130	25	1,234
B1600120	120-140	25	1,289
B1600130	130-150	25	1,392



Acero cincado
Zinc plated

Ancho 9 mm.
9 mm wide.

Disponibile en Acero Inox p. 70.
Available in stainless steel p. 70.

TIRAFONDOS GRAPA

STAPLE SCREW

Pincha QR para ver ficha técnica.



Ref. 2110

Referencia	M x L (mm)		€ u.
211025	4,3 x 25	250	0,109
21104925	4,9 x 25	250	0,155
211030	5 x 30	250	0,178
211040	5,6 x 40	200	0,279

Acero cincado
Zinc plated

GRAPA 1 PIE

"F" TYPE CLIP

Pincha QR para ver ficha técnica.



Ref. 1910

Referencia	Ø (mm)		P"			€ u.
191006	6				100	0,061
191008	8	8			100	0,067
191010	10	10	1/8		100	0,070
191012	12	12	1/4		100	0,081
191014	14	14			100	0,087
191015	15	15			100	0,092
191016	16	16		16	100	0,099
191018	18	18	3/8	18	100	0,130
191020	20			20	100	0,137
191022	22	22	1/2		100	0,146
191025	25			25	100	0,178
191026	26		3/4	26	100	0,180
191028	28	28			100	0,186
191030	30				100	0,193
191032	32		1"	32	100	0,196
191037	37				100	0,236
191040	40			40	50	0,259
191042	42	42	1" 1/4		50	0,309
191047	47		1" 1/2		50	0,317
191050	50			50	50	0,400



GRAPA PUENTE

"U" TYPE CLIP

Pincha QR para ver ficha técnica.



Ref. 1920

Referencia	Ø (mm)		P"			€ u.
192008	8	8			100	0,150
192010	10	10	1/8		100	0,155
192012	12	12	1/4		100	0,159
192014	14	14			100	0,161
192015	15	15			100	0,163
192016	16	16		16	100	0,164
192018	18	18	3/8	18	100	0,227
192020	20			20	100	0,237
192022	22	22	1/2		100	0,248
192025	25				100	0,260
192026	26		3/4	26	100	0,264
192028	28	28			100	0,271
192030	30				50	0,322
192032	32		1"	32	100	0,335
*192037	37				100	0,340
192040	40			40	50	0,343
192042	42	42	1" 1/4		100	0,396
192047	47		1" 1/2		100	0,414
192050	50			50	50	0,582
192060	60		2"		50	0,820

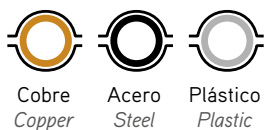

* Hasta final de existencias. / Until end of stocks.

Abrazaderas de plástico



Ref. 1329 | Pág. 38



Ref. 1311 | Pág. 39



Ref. 1312 | Pág. 39



Ref. 1340 | Pág. 39



Ref. 1342 | Pág. 39



Ref. 1300 | Pág. 40



Ref. 1333 | Pág. 40



Ref. 1310 | Pág. 40



Ref. 1360 | Pág. 41



Ref. 1362 | Pág. 41

ABRAZADERA MÚLTIPLE HYDRA 1000 NYLON

MULTIPLE CLAMP HYDRA 1000



Pincha QR para ver ficha técnica.

MULTITODO

MULTITUBO:

Para más de 9 clases de tubos diferentes.

For more than 9 different pipe models.

Plástico multicapa:

Plástico PPR.

Plástico métrica (antes PG).

Plástico PE. Plástico PP.

Plástico PB. Plástico PVC.

Hierro. Cobre. Acero Inoxidable.

Plastic PPR.

Metric plastic. Plastic PE.

Plastic PP. Plastic PB.

Plastic PVC.

Iron. Copper. Stainless steel.

MULTIDIÁMETRO:

Con tres medidas de abrazaderas abarcamos 10 diámetros, desde Ø15 hasta Ø32.

With three sizes of clamps, we cover 9 diameters, from 15 to 32.

MULTICOLOR:

Disponible en blanco y gris. Para más colores consultar condiciones.

Available in white and grey. Consult conditions for more possibilities.

MULTIFIJACIÓN

Se fija al soporte con tirafondo M6.

Tirafondo normal. Tiro de pistola.

Fixed to the support with M6 connecting screw.



Tirafondo alomado

Tiro de pistola

Tirafondo avellanado

Tirafondo M6

Pre rosca M6.
Rápida colocación.
*M6 Thread.
Easy installation.*

MODELO ÚNICO sin accesorios

MULTIGUÍAS

20 x 10 25 x 7,5 27 x 18



Cobre Plástico
Copper Plastic

Disponible en Autoservicio p. 155.
Available in self-service p. 155.

Ref. 1329B

Referencia	Ø (mm)	Color				€ u.
132915B	15-18	Blanco	15-18	15-18	100	0,308
132920B	20-25	Blanco	22	20-25	50	0,370
132925B	25-32	Blanco	28	25-32	50	0,490

Ref. 1329G

Referencia	Ø (mm)	Color				€ u.
132915G	15-18	Gris	15-18	15-18	100	0,308
132920G	20-25	Gris	22	20-25	50	0,370
132925G	25-32	Gris	28	25-32	50	0,490

CUBO DE ABRAZADERAS HYDRA 1000

Ref. 1329QB



Referencia	Ø (mm)	Color				€ cubo
1329Q15B	15-18	Blanco	15-18	15-18	200	65,405
1329Q20B	20-25	Blanco	22	20-25	150	60,755
1329Q25B	25-32	Blanco	28	25-32	100	53,820



Poliamida
Polyamide



Rápida instalación
Easy installation



Libre de halógenos
Halogen free



Reducción de sonido
Sound reduction



Ultravioleta
Ultraviolet

CLIP M6 NYLON

M6 SINGLE PLASTIC CLIP

Modelo original.
Original model.



Cobre
Copper



Plástico
Plastic



Disponible en Autoservicio p. 155.
Available in self-service p. 155.

Ref. 1311

Pincha QR para ver ficha técnica.



Referencia	Ø (mm)				€ u.
131112	12	12		100	0,292
131115	14-15	15		100	0,322
131118	16-18	18	16	100	0,395
131122	20-22	22	20	100	0,414
131125	25		25	100	0,428
131128	28	28		50	0,530



Poliamida
Polyamide



Rápida instalación
Easy installation



Libre de halógenos
Halogen free



Casquillo metálico M6
M6 metallic socket



Ultravioleta
Ultraviolet

CLIP DOBLE M6 NYLON

M6 DOUBLE PLASTIC CLIP

Modelo original.
Original model.



Cobre
Copper



Plástico
Plastic

Ref. 1312

Pincha QR para ver ficha técnica.



Referencia	Ø (mm)				€ u.
131212	12	12		50	0,488
131215	14-15	15		50	0,528
131218	16-18	18	16	50	0,648
131222	20-22	22	20	50	0,699
131228	28	28		25	0,952



Poliamida
Polyamide



Rápida instalación
Easy installation



Libre de halógenos
Halogen free



Casquillo metálico M6
M6 metallic socket



Ultravioleta
Ultraviolet

FIX-RING NYLON

FIX-RING

Modelo original.
Original model.



Cobre
Copper



Plástico
Plastic

Ref. 1340

Pincha QR para ver ficha técnica.



Referencia	Ø (mm)				€ u.
134014	14	14		100	0,288
134016	16	16	16	100	0,315
134018	18	18		100	0,360
134020	20		20	100	0,363
134022	22	22		100	0,391
134025	25		25	100	0,394
134028	28	28		50	0,500
134032	32		32	50	0,601



Poliamida
Polyamide



Rápida instalación
Easy installation



Libre de halógenos
Halogen free



Ultravioleta
Ultraviolet

FIX-RING DOBLE NYLON

DOUBLE FIX-RING

Modelo original.
Original model.



Cobre
Copper



Plástico
Plastic

Ref. 1342

Pincha QR para ver ficha técnica.



Referencia	Ø (mm)				€ u.
134216	16	16	16	100	0,388
134218	18	18		50	0,447
134220	20		20	50	0,456
134222	22	22		50	0,496
134225	25		25	50	0,547
134228	28	28		50	0,720



Poliamida
Polyamide



Rápida instalación
Easy installation



Libre de halógenos
Halogen free



Ultravioleta
Ultraviolet

ABRAZADERA CIERRE

CLOSING CLAMP



* Ref. 1300

Pincha QR para ver ficha técnica.



Cobre
Copper

Plástico
Plastic



PVC autoextinguible
Self-extinction PVC



Rápida instalación
Easy installation

Referencia	Ø (mm)				€ u.
130012	12	12		200	0,413
130015	15	15		100	0,420
130016	16	16	16	100	0,460
130018	18	18		100	0,490
130020	20		20	100	0,500
130022	22	22		100	0,506
130025	25		25	50	0,557
130028	28	28		100	0,561
130032	32		32	100	0,643
130040	40	40	40	50	0,730
130050	50		50	25	0,903
1300GM	Guía met. 1 m			10	6,337

* Hasta final de existencias.
Until end of stocks.

ABRAZADERA CIERRE NYLON

NYLON CLOSING CLAMP



Ref. 1333

Pincha QR para ver ficha técnica.

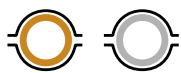

Cobre
Copper

Plástico
Plastic



Poliamida
Polyamide



Rápida instalación
Easy installation



Libre de halógenos
Halogen free



Ultravioleta
Ultraviolet

Referencia	Ø (mm)				€ u.
133312	12	12		100	0,310
133315	15	15		100	0,340
133316	16	16	16	100	0,347
133318	18	18		100	0,388
133320	20		20	100	0,413
133322	22	22		100	0,424
133325	25		25	100	0,463
133328	28	28		50	0,575
133332	32		32	25	0,664
133335	35	35		25	0,784
133337	37			25	0,826
133340	40	40	40	25	0,913
133342	42			25	0,927
133347	47			25	0,970
133350	50		50	25	1,241
1333GM2	Guía met. 2 m			30	6,496

PINZA NYLON

NYLON CLIP



Ref. 1310

Pincha QR para ver ficha técnica.

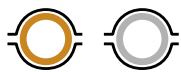

Cobre
Copper

Plástico
Plastic



Poliamida
Polyamide



Rápida instalación
Easy installation



Libre de halógenos
Halogen free



Ultravioleta
Ultraviolet

Referencia	Ø (mm)				€ u.
131010	10	10		100	0,274
131012	12	12		100	0,278
131015	15-16	15	16	100	0,321
131018	18	18		100	0,362
131022	20-22	22	20	100	0,422
131025	25		25	100	0,522
131028	28	28		50	0,582
131032	32		32	25	0,744
131037	35-37	35		25	0,844
131040	40	40	40	25	0,986
131047	47			25	1,607
1333GM2	Guía met. 2 m			30	6,496

ABRAZADERA HYDRACTN NYLON

HYDRACTN CLAMP

Ref. 1360

Pincha QR para ver ficha técnica.



Modelo original.
Original model.

Referencia	Ø (mm)				€ u.
136012	12	12		100	0,324
136015	14-15	15		100	0,439
136016	16	16	16	100	0,443
136018	18	18		100	0,591
136020	20		20	100	0,594
136022	22	22		100	0,597
136024	24-25		25	50	1,185
136028	28	28		50	1,192

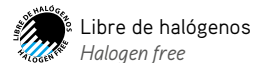
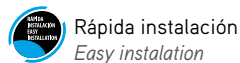
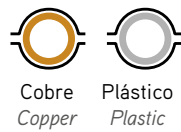

ABRAZADERA HYDRACTN DOBLE NYLON

DOUBLE HYDRACTN CLAMP

Ref. 1362

Pincha QR para ver ficha técnica.



Modelo original.
Original model.

Referencia	Ø (mm)				€ u.
136212	12	12		100	0,545
136215	14-15	15		100	0,547
136216	16	16	16	100	0,565
136218	18	18		50	0,796
136220	20		20	50	0,861
136222	22	22		50	0,974
136228	28	28		25	1,567

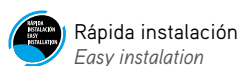
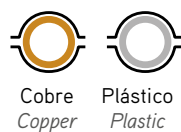

NOTA: Bajo demanda se pueden suministrar en cubos las referencias 1310, 1311, 1312, 1333, 1340, 1342, 1360 y 1362.

Accesorios de montaje



Ref. 2300 | Pág. 43



Ref. 2305 | Pág. 43



Ref. 2310 | Pág. 43



Ref. 2311 | Pág. 43



Ref. 2550 | Pág. 44



Ref. 2940 | Pág. 44



Ref. 2555 | Pág. 44



Ref. 2115 | Pág. 44



Ref. 2720 | Pág. 45



Ref. 2730 | Pág. 45



Ref. 2740E | Pág. 45



Ref. 2740G | Pág. 45



Ref. 2700CB | Pág. 45



Ref. 2700CA | Pág. 45



Ref. 2910 | Pág. 46



Ref. 2912 | Pág. 46



Ref. 2920 | Pág. 46



Ref. 2930 | Pág. 46



Ref. 2931 | Pág. 46



Ref. 2950 | Pág. 47



Ref. 2101 | Pág. 47



Ref. A9430 | Pág. 47



Ref. 9430 | Pág. 47



Ref. 2900 | Pág. 48



Ref. 2103 | Pág. 48



Ref. 2100 | Pág. 48



Ref. 2670 | Pág. 49



Ref. 2600 | Pág. 49



Ref. 2610 | Pág. 49



Ref. 2650 | Pág. 49



Ref. 1900 | Pág. 50



Ref. 2400J | Pág. 50



Ref. 2400K | Pág. 50



Ref. 2400JI | Pág. 51



Ref. 2400KI | Pág. 51



Ref. 2400A | Pág. 52



Ref. 2400B | Pág. 52



Ref. 2400B2 | Pág. 52



Ref. 2400C | Pág. 52



Ref. 2400G | Pág. 52



Ref. 2400H | Pág. 52



Ref. 2400M | Pág. 53



Ref. 2400MG | Pág. 53



Ref. 2400D | Pág. 53



Ref. 2400I | Pág. 53



Ref. 2500A | Pág. 54



Ref. 2500B | Pág. 54



Ref. 2500C | Pág. 54



Ref. 2500D | Pág. 54



Ref. 2500E | Pág. 54



Ref. 2500F | Pág. 54

MANGUITO HEXAGONAL

HEXAGONAL SPACER



Disponible en Acero Inox p. 71.
Available in stainless steel p. 71.

Disponible en Autoservicio p. 158.
Available in self-service p. 158.

Ref. 2300

Pincha QR para ver ficha técnica.



Referencia	R/L (mm)		€ u.
2300420	M-4 x 20	250	0,384
2300620	M-6 x 20	250	0,314
2300630	M-6 x 30	150	0,494
2300820	M-8 x 20	100	0,495
2300830	M-8 x 30	100	0,687
23001030	M-10 x 30	50	0,713
23001235	M-12 x 35	25	1,450

Acero cincado
Zinc plated

MANGUITO REDONDO

ROUND SPACER



Ref. 2305

Pincha QR para ver ficha técnica.



Referencia	R/L (mm)		€ u.
23050620	M-6 x 20	250	0,323
23050630	M-6 x 30	150	0,432
23050820	M-8 x 20	100	0,434
23050830	M-8 x 30	100	0,529

Acero cincado
Zinc plated

ESPÁRRAGO CON SEPARADOR

THREADED ROD WITH RING



* Ref. 2310

Pincha QR para ver ficha técnica.



Referencia	R/L (mm)		€ u.
2310620	M-6 x 20	200	0,271
2310630	M-6 x 30	100	0,498
2310830	M-8 x 30	100	0,659

Acero cincado
Zinc plated

* Hasta final de existencias. /
Until end of stocks.

ESPÁRRAGO

THREADED ROD



Disponible en Autoservicio p. 158.
Available in self-service p. 158.

Ref. 2311

Pincha QR para ver ficha técnica.



Referencia	R/L (mm)		€ u.
2311420	M-4 x 20	250	0,111
2311620	M-6 x 20	100	0,171
2311630	M-6 x 30	100	0,214
2311820	M-8 x 20	100	0,227
2311830	M-8 x 30	100	0,356
23111030	M-10 x 30	50	0,413
23111230	M-12 x 30	50	2,360

Acero cincado
Zinc plated

JUEGO TIRAFONDOS SOPORTE CALENTADORES

SCREWS FOR WATER HEATER SUPPORT

Ref. 2550

Pincha QR para ver ficha técnica.



Referencia	R/L (mm)	Ø taco		€ bolsa
2550860	8 x 60	10	100 bolsas	1,223
2550870	8 x 70	10	100 bolsas	1,324
2551080	10 x 80	12	100 bolsas	2,318

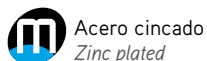

En bolsas de 2 unidades
In bags of 2 units

TORNILLO BARRAQUERO

HEXAGONAL SCREW

Ref. 2940

Pincha QR para ver ficha técnica.



Referencia	R/L (mm)		€ u.
2940540	5 x 40	200	0,086
2940640	6 x 40	200	0,112
2940650	6 x 50	200	0,132
2940660	6 x 60	200	0,153
2940780	7 x 80	100	0,335
2940850	8 x 50	200	0,249
2940860	8 x 60	100	0,285
2940870	8 x 70	100	0,343
2940880	8 x 80	100	0,362
2940890	8 x 90	100	0,401
29401080	10 x 80	100	0,617



JUEGO DE ALCAYATAS

L-WOOD SCREW + PLUG

Ref. 2555

Pincha QR para ver ficha técnica.



Referencia	M/L (mm)	Ø taco		€ bolsa
25550865	8 x 65	10	100 bolsas	1,183
25551075	10 x 75	12	100 bolsas	1,826



En bolsas de 2 unidades
In bags of 2 units

TORNILLO POZI

POZY SCREW

Ref. 2115

Pincha QR para ver ficha técnica.



Referencia	M/L (mm)		€ u.
211535030	3,5 x 30	1000	0,034
211535035	3,5 x 35	500	0,040
211540040	4,0 x 40	500	0,049
211545030	4,5 x 30	500	0,055
211545035	4,5 x 35	500	0,058
211545045	4,5 x 45	250	0,074
211545050	4,5 x 50	250	0,086
211560050	6,0 x 50	250	0,145



VUELCO ESPIGA

BASCULE STUD



Acero cincado
Zinc plated

Ref. 2720

Pincha QR para ver ficha técnica.



Referencia	R		€ u.
272004	M-4	100	0,828
272005	M-5	50	1,009
272006	M-6	50	1,440
272008100	M-8	50	3,760

VUELCO GANCHO

BASCULE HOOK



Acero cincado
Zinc plated

Ref. 2730

Pincha QR para ver ficha técnica.



Referencia	R		€ u.
273004	M-4	100	0,937
273005	M-5	50	1,081
273006	M-6	50	1,639

ARPÓN ESPIGA

SPRING TOGGLE STUD



Disponible en Autoservicio p. 159.
Available in self-service p. 159.

Acero cincado
Zinc plated

Ref. 2740E

Pincha QR para ver ficha técnica.



Referencia	R		€ u.
2740E04	M-4	100	0,774
2740E05	M-5	50	0,919
2740E06	M-6	50	1,253

ARPÓN GANCHO

SPRING TOGGLE HOOK



Disponible en Autoservicio p. 159.
Available in self-service p. 159.

Acero cincado
Zinc plated

Ref. 2740G

Pincha QR para ver ficha técnica.



Referencia	R		€ u.
2740G04	M-4	100	0,847
2740G05	M-5	50	1,049
2740G06	M-6	50	1,444

CABEZA BASCULANTE

TOGGLE



Acero cincado
Zinc plated

Ref. 2700CB

Pincha QR para ver ficha técnica.



Referencia	R		€ u.
2700CB06	M-6	100	0,518
2700CB08	M-8	50	0,749

CABEZA ARPÓN

TOGGLE



Disponible en Autoservicio p. 159.
Available in self-service p. 159.

Acero cincado
Zinc plated

Ref. 2700CA

Pincha QR para ver ficha técnica.



Referencia	R		€ u.
2700CA04	M-4	100	0,27
2700CA06	M-6	100	0,393

TUERCA HEXAGONAL

HEXAGONAL NUT



Acero cincado
Zinc plated

Disponible en Acero Inox p. 71.
Available in stainless steel p. 71.

Disponible en Autoservicio p. 158.
Available in self-service p. 158.

Ref. 2910

Pincha QR para ver ficha técnica.



Referencia	R		€ u.
291004	M-4	1000	0,022
291006	M-6	200	0,034
291008	M-8	200	0,067
291010	M-10	100	0,214
291012	M-12	100	0,297
291016	M-16	50	0,396
291018	M-18	50	0,935
291020	M-20	50	1,173
291022	M-22	50	1,494

TUERCA AUTOBLOCANTE

SELF-LOCK NUT



Acero cincado
Zinc plated

Disponible en Autoservicio p. 159.
Available in self-service p. 159.

* Ref. 2912

Pincha QR para ver ficha técnica.



Referencia	R		€ u.
291204	M-4	1000	0,024
291212	M-12	100	0,193

* Hasta final de existencias. / Until end of stocks.

ARANDELA PLANA

FLAT WASHER



Acero cincado
Zinc plated

Disponible en Acero Inox p. 70.
Available in stainless steel p. 70.

Disponible en Autoservicio p. 159.
Available in self-service p. 159.

Ref. 2920

Pincha QR para ver ficha técnica.



Referencia	Ø (mm)	Ø exterior		€ u.
292004	4	9	1000	0,032
292006	6	12	200	0,037
292008	8	16	250	0,052
292010	10	21	200	0,105
292012	12	24	50	0,187
292016	16	30	50	0,325

ARANDELA PLANA ANCHA

WIDE FLAT WASHER



Acero cincado
Zinc plated

Disponible en Autoservicio p. 158.
Available in self-service p. 158.

Ref. 2930

Pincha QR para ver ficha técnica.



Referencia	Ø (mm)	Ø exterior		€ u.
293004	4	12	200	0,037
293006	6	18	200	0,076
293008	8	24	200	0,170
293010	10	30	200	0,434
293012	12	35	100	0,580

TORNILLO DIN 931

DIN 931 SCREW



Acero cincado
Zinc plated

Ref. 2931

Pincha QR para ver ficha técnica.



Referencia	M x L (mm)		€ u.
293116060	M16 x 60	20	2,594
293116080	M16 x 80	25	3,235
293116110	M16 x 110	25	4,268
293116130	M16 x 130	25	4,885
293116150	M16 x 150	20	5,590

TORNILLO DIN 933

DIN 933 SCREW



Ref. 2950

Pincha QR para ver ficha técnica.



Acero cincado
Zinc plated

Referencia	M x L (mm)		€ u.
29500620	M6 x 20	500	0,140
29500630	M6 x 30	400	0,182
29500640	M6 x 40	200	0,222
29500650	M6 x 50	200	0,277
29500820	M8 x 20	200	0,273
29500830	M8 x 30	200	0,342
29500840	M8 x 40	200	0,431
29500850	M8 x 50	200	0,473
29501030	M10 x 30	100	0,578
29501040	M10 x 40	100	0,684
29501050	M10 x 50	100	0,873

TIRAFONDO HEMBRA

CONNECTING SCREW



* Ref. 2101

Pincha QR para ver ficha técnica.



Acero cincado negro
Black zinc plated

Referencia	R/L (mm)		€ u.
210106	M6 x 34	100	0,906
210108	M8 x 34	100	0,929

* Hasta final de existencias. / Until end of stocks.



TACO + TORNILLO HEXAGONAL PARA FACHADAS

PLUG + HEXAGONAL SCREW FOR FACADE



Ref. A9430

Referencia	Ø/L (mm)		€ bolsa
A943010080	10 x 80	15 bolsas	12,272



Acero cincado
Zinc plated



Poliamida
Polyamide

TACO + TORNILLO HEXAGONAL PARA FACHADAS

PLUG + HEXAGONAL SCREW FOR FACADE



Ref. 9430

Pincha QR para ver ficha técnica.



Referencia	Ø/L (mm)		€ u.
943010080	10 x 80	50	1,549
943010100	10 x 100	25	1,683



Acero cincado
Zinc plated



Poliamida
Polyamide

VARILLA ROSCADA

THREADED ROD



1 metro - Ref. 2900

Pincha QR para ver ficha técnica.



Referencia	R/L (mm)			€ u.
290004	M4 x 1000	200	14000	1,520
*290005	M5 x 1000	100	8000	0,906
290006	M6 x 1000	100	6000	1,167
290008	M8 x 1000	50	4000	1,797
290010	M10 x 1000	25	2000	3,357
290012	M12 x 1000	25	1750	4,900
290014	M14 x 1000	10	1000	7,841
290016	M16 x 1000	10	800	10,846
290018	M18 x 1000	10	700	15,526
290020	M20 x 1000	10	500	20,966
290022	M22 x 1000	5	400	26,985



Acero cincado
Zinc plated

Disponible en Acero Inox p. 71.
Available in stainless steel p. 71.

* Hasta final de existencias. / Until end of stocks.

2 metros - Ref. 2900

Referencia	R/L (mm)			€ u.
2900062	M6 x 2000	50	3000	2,659
2900082	M8 x 2000	25	2000	4,405

TIRAFONDO DOBLE ROSCA (DOWELL)

DOUBLE THREADED SCREW (DOWELL)



Ref. 2103

Pincha QR para ver ficha técnica.

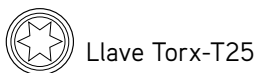

Llave Torx-T25

Disponible en Acero Inox p. 70.
Available in stainless steel p. 70.



Acero cincado
Zinc plated

Disponible en Autoservicio p. 157.
Available in self-service p. 157.

Referencia	R x L (mm)			€ u.
210308060	M8 x 60	100	1000	0,245
210308080	M8 x 80	100	1000	0,266
210308090	M8 x 90	100	1000	0,297
210308100	M8 x 100	100	1000	0,331
210308110	M8 x 110	100	1000	0,383
210308120	M8 x 120	100	1000	0,587
210308140	M8 x 140	100	1000	0,821
210310090	M10 x 90	100	800	0,466
210310100	M10 x 100	50	500	0,572
210310110	M10 x 110	50	500	0,575
210310120	M10 x 120	50	500	0,678

TIRAFONDO ABRAZADERA

CONNECTING SCREW



Ref. 2100

Pincha QR para ver ficha técnica.

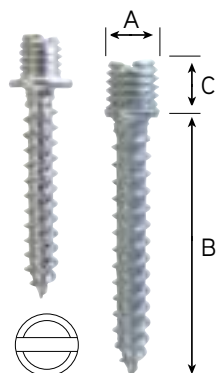

Disponible en Acero Inox p. 69.
Available in stainless steel p. 69.

Disponible en Autoservicio p. 157.
Available in self-service p. 157.



Acero cincado
Zinc plated

Referencia	A x B x C (mm)		€ u.
2100630	M6 x 30 x 6	100	0,103
2100640	M6 x 40 x 6	100	0,140
2100650	M6 x 50 x 6	100	0,199
2100840	M8 x 40 x 7	100	0,282
2100860	M8 x 60 x 7	100	0,513
21001050	M10 x 50 x 10	50	0,743

BROCA ACERO SÚPER RÁPIDO HSS

HSS SUPER FAST DRILL BIT



Para metal
For metal



No laminada
Non rolled



Acero pavonado
Blue steel

Otras medidas consultar.
Other measures, please consult.

* Ref. 2670

Pincha QR para ver ficha técnica.

Referencia	Ø/L (mm)		€ u.
2670060	6 x 93	1	2,876
2670075	7,5 x 109	1	4,667
2670080	8 x 117	1	6,255
2670085	8,5 x 117	1	6,041
2670095	9,5 x 125	1	7,391

* Hasta final de existencias. / Until end of stocks.

BROCA DE "WIDIA"

WIDIA DRILL BIT



Ladrillo hueco
Hollow brick



Ladrillo macizo
Massive brick



Hormigón
Concrete



Pladur
Cardboard plaster



Acero cincado
Zinc plated



Bolsa individual con colgador
Single bag with hanger

Ref. 2600

Pincha QR para ver ficha técnica.

Referencia	Ø/L (mm)		€ u.
260005	5 x 85	1	2,048
260006	6 x 100	1	2,328
260008	8 x 120	1	3,308
260010	10 x 120	1	5,828
260012	12 x 150	1	8,978

BROCA ÓPTIMA

OPTIMUM DRILL BIT



Ladrillo hueco
Hollow brick



Ladrillo macizo
Massive brick



Hormigón
Concrete



Pladur
Cardboard plaster



Acero pulido
Polished steel



Bolsa individual con colgador
Single bag with hanger

* Ref. 2610

Pincha QR para ver ficha técnica.

Referencia	Ø/L (mm)		€ u.
261006	6 x 100	1	7,751
261008	8 x 120	1	9,222
261012	12 x 150	1	12,650

* Hasta final de existencias. / Until end of stocks.

BROCA SDS PLUS

SDS PLUS DRILL BIT



Ladrillo hueco
Hollow brick



Ladrillo macizo
Massive brick



Hormigón
Concrete



Pladur
Cardboard plaster



Acero pulido
Polished steel



Bolsa individual con colgador
Single bag with hanger

Ref. 2650

Pincha QR para ver ficha técnica.

Referencia	Ø/L (mm)		€ u.
265004110	4 x 110	1	11,950
265005110	5 x 110	1	5,740
265006110	6 x 110	1	5,460
265008110	8 x 110	1	5,740
265010110	10 x 110	1	6,930
265012160	12 x 160	1	11,183

CINTA PERFORADA

PERFORATED TAPE

Pincha QR para ver ficha técnica.



Ref. 1900

Referencia	M	Ancho	Espesor	Perforación	M/R		€ u.
190012	12 x 0,70	12	0,7	Ø5 (mm)	10	10 rollos	8,060
190017	17 x 0,70	17	0,7	Ø7 (mm)	10	10 rollos	8,835



Disponible en Acero Inox p. 67.
Available in stainless steel p. 67.



Acero galvanizado
Galvanized steel



Polietileno
Polyethylene



Cobre
Copper



Acero
Steel



Plástico
Plastic

SOPORTES Y TAPAS DE CONTADOR DE GAS

SUPPORTS AND COVERS GAS METER

Ref. 2400

Pincha QR para ver ficha técnica.

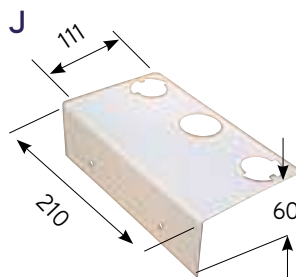

Referencia	T	D		€ u.
2400J	J	Soporte frontal contador gas	40	4,278



Acero con pintura epoxi
Epoxy painted steel

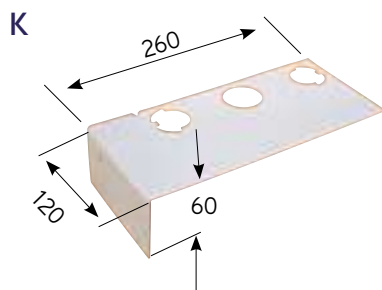

Referencia	T	D		€ u.
2400K	K	Soporte lateral contador gas	30	4,738

Pincha QR para ver ficha técnica.



Acero con pintura epoxi
Epoxy painted steel

Debido a nuestro proceso de mejora continua, algunas medidas pueden variar ligeramente.
Due to our continuous improvement process, dimensions may vary.

SOPORTE CONTADOR DE GAS FRONTAL ACERO INOX. AISI 316 CON ACCESORIOS

FRONT GAS SUPPORT AISI 316 WITH ACCESSORIES

Ref. 2400

Pincha QR para ver ficha técnica.



Referencia	T	D		€ u.
2400JI	JI	Soporte frontal contador gas Inox.	1	66,700

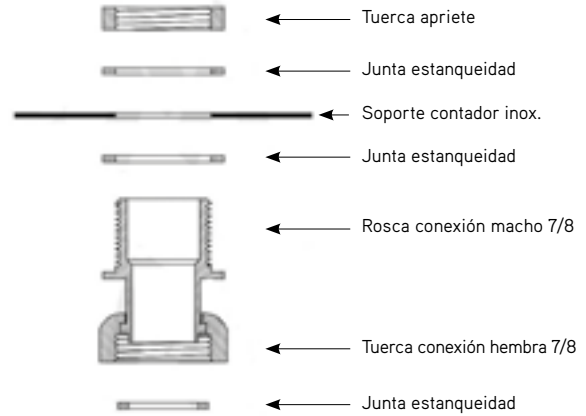
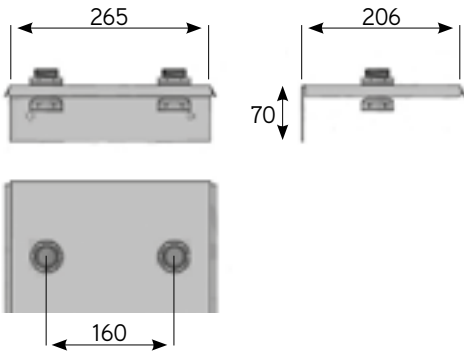
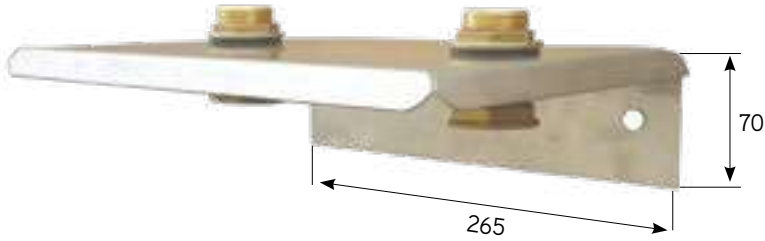

 Acero inoxidable Aisi 316.
2 mm de espesor.
Stainless steel Aisi 316

 Latón
Brass

SOPORTE LATERAL CONTADOR DE GAS FRONTAL ACERO INOX. AISI 316

LATERAL SUPPORT OF FRONTAL GAS AISI 316

Ref. 2400

Pincha QR para ver ficha técnica.



Referencia	T	D		€ u.
2400KI	KI	Soporte lateral contador gas Inox.	1	22,770

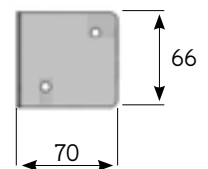
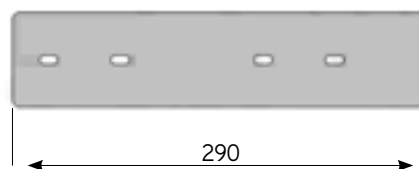

 Acero inoxidable Aisi 316.
2 mm de espesor.
Stainless steel Aisi 316.

SOPORTES DE RADIADOR

RADITATOR SUPPORT

Ref. 2400

Pincha QR para ver ficha técnica.



Referencia	T	D	L (mm)		€ u.
*2400A2	A	Para radiador 2 columnas empotrar de 1"1/4	150	100	0,604
*2400A3	A	Para radiador 3 columnas empotrar de 1"1/4	165	100	0,717

* Hasta final de existencias. / Until end of stocks.



Pincha QR para ver ficha técnica.

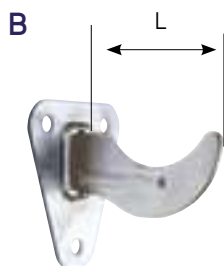

Referencia	T	D	L (mm)		€ u.
2400B095	B	Alicatar 95 mm para radiador de 1" 1/4	95	100	1,277
2400B105	B	Alicatar 105 mm para radiador de 1" 1/4	105	100	1,368



Pincha QR para ver ficha técnica.

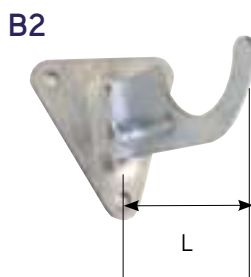

Referencia	T	D	L (mm)		€ u.
2400B2090	B2	Alicatar 90 mm para radiador de 1"	90	100	1,776



Pincha QR para ver ficha técnica.

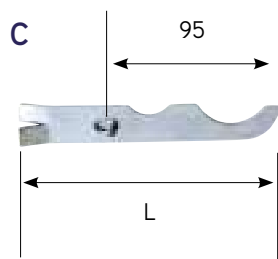

Referencia	T	D	L (mm)		€ u.
2400C	C	Para radiador Ferroli empotrar de 1"	150	100	0,676



Pincha QR para ver ficha técnica.

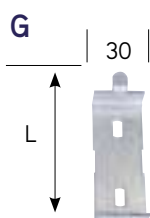

Referencia	T	D	L (mm)		€ u.
2400G	G	Uña. Para radiador de aluminio	80	100	0,731



Pincha QR para ver ficha técnica.

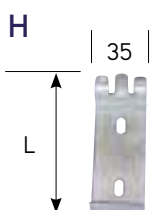

Referencia	T	D	L (mm)		€ u.
2400H	H	Tipo rayco	80	100	0,839

Acero cincado
Zinc plated

SOPORTES DE RADIADOR REGULABLES

RADITATOR METER SUPPORT

Ref. 2400

Pincha QR para ver ficha técnica.



Referencia	T	D	L (mm)		€ bolsa
2400M	M	Bolsa 2 conjuntos soporte triangular regulable para radiador de 1"	95	40 bolsas	3,601

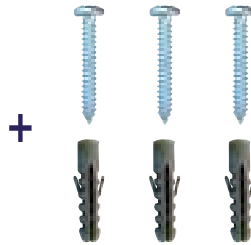
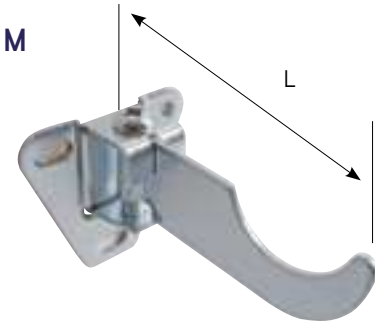

 Se entregan en bolsas que contienen dos conjuntos
2 sets in each bag

Referencia	T	D	L (mm)		€ bolsa
2400MG	M	Soporte por unidades sueltos. Soporte triangular regulable para radiador de 1"	95	100 u.	1,595

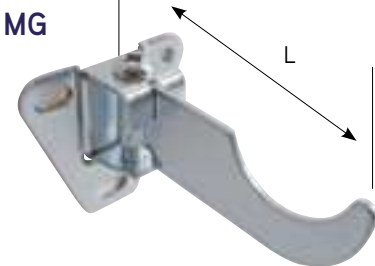

 Contienen 100 unidades a granel, sin accesorios.
Contains 100 units in bulk without fittings.

Referencia	T	D	L (mm)		€ bolsa
2400D	D	Bolsa 2 conjuntos alicatar Ferroli regulable para radiador de 1"	95	100 bolsas	3,448

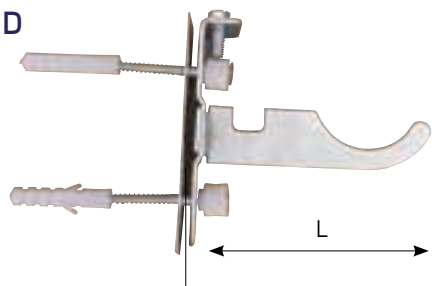



Pincha QR para ver ficha técnica.

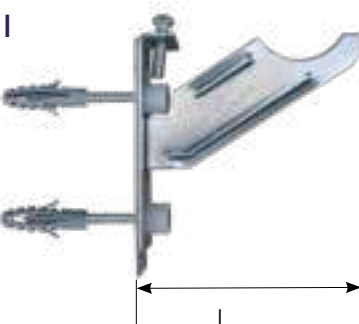

 Se entregan en bolsas que contienen dos conjuntos
2 sets in each bag

Referencia	T	D	L (mm)		€ bolsa
2400I	I	Bolsa 2 conjuntos para radiador de aluminio oculto de 1"	90	50 bolsas	4,556



 Se entregan en bolsas que contienen dos conjuntos
2 sets in each bag

 Acero cincado
Zinc plated

 Polipropileno
Polypropylene



Pincha QR para ver ficha técnica.



BOLSAS DE SANITARIO

SANITARY SET

Ref. 2500

Pincha QR para ver ficha técnica.



Bolsa 2 unidades

Referencia	Conjunto	D	📦	€ bolsa
2500A08	A	Lavabo 8 x 100 T. Hierro	50 bolsas	1,364
2500A10	A	Lavabo 10 x 110 T. Hierro	40 bolsas	2,052



Acero bicromatado
Yellow zinc plated

En bolsas de 2 unidades
In bags of 2 units

Pincha QR para ver ficha técnica.



Bolsa 2 unidades

Referencia	Conjunto	D	📦	€ bolsa
2500CB	C	Vertical 5 x 75 Bicromatado	250 bolsas	0,997
2500CL	C	Vertical 5 x 75 Latón	250 bolsas	2,575
2500CITL	C	Vertical 5 x 75 Inox T. Latón	100 bolsas	3,177
2500CITI	C	Vertical 5 x 75 Inox. T. Inox.	100 bolsas	2,356
*2500CL670	C	Vertical 6 x 70 Latón T. Inox.	100 bolsas	3,254



* Hasta final de existencias. / Until end of stocks.

Acero bricomatado
Yellow zinc plated

Latón
Brass

Acero inoxidable
Stainless steel

En bolsas de 2 unidades
In bags of 2 units

Pincha QR para ver ficha técnica.



Bolsa 2 unidades

Referencia	Conjunto	D	📦	€ bolsa
2500D	D	Horizontal (tipo góndola)	200 bolsas	1,651



En bolsas de 2 unidades
In bags of 2 units

Acero bricomatado
Yellow zinc plated

Pincha QR para ver ficha técnica.



Bolsa 2 unidades

Referencia	Conjunto	D	📦	€ bolsa
2500E	E	Fijación WC horizontal	50 bolsas	6,888

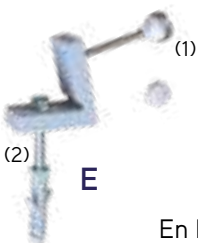

En bolsas de 2 unidades
In bags of 2 units

(1) Acero inoxidable
Stainless steel

(2) Acero cincado
Zinc plated

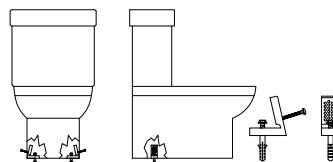

Bolsa 2 unidades

Referencia	Conjunto	D	📦	€ bolsa
2500FG	F	Tornillo taza 6 x 80 cincado	100 bolsas	2,645
2500FI	F	Tornillo taza 6 x 80 Inox.	100 bolsas	4,077



Acero cincado
Zinc plated

Acero inoxidable
Stainless steel

En bolsas de 2 unidades
In bags of 2 units

Anclajes



Ref. 9200 | Pág. 56



Ref. 9200H | Pág. 56



Ref. 9205 | Pág. 56



Ref. 9250 | Pág. 56



Ref. 9100 | Pág. 56



Ref. 9300T | Pág. 57



Ref. 9300E | Pág. 57



Ref. 9300G | Pág. 57



Ref. 9300A | Pág. 57



Ref. 9600C | Pág. 58



Ref. 9600E | Pág. 58



Ref. 9600T | Pág. 58



Ref. 9600P | Pág. 58



Ref. 9600M | Pág. 58

ANCLAJE HEMBRA

DROP IN ANCHOR



Ref. 9200

Pincha QR para ver ficha técnica.



Disponible en Acero Inox p. 67.
Available in stainless steel p. 67.

Acero cincado
Zinc plated

Disponible en Autoservicio p. 157.
Available in self-service p. 157.

Referencia	R / L (mm)	Ø ext. (mm)		€ u.
920006	M-6 x 25	8	100	0,148
920008	M-8 x 30	10	100	0,189
920010	M-10 x 40	12	50	0,432
920012	M-12 x 50	15	50	1,151
920016	M-16 x 65	20	25	2,420

ANCLAJE HEMBRA HOMOLOGADO

DROP IN ANCHOR APPROVED



Ref. 9200H

Pincha QR para ver ficha técnica.



Acero cincado
Zinc plated



Referencia	R / L (mm)	Ø ext. (mm)		€ u.
920008H	M-8 x 30	10	100	0,597
920010H	M-10 x 40	12	100	1,610
920012H	M-12 x 50	15	50	1,658

EXPANSIONADOR MANUAL ANCLAJE HEMBRA

DROP IN ANCHOR EXPANDER



Ref. 9205

Pincha QR para ver ficha técnica.



Acero cincado
Zinc plated

Referencia	Ø (mm)		€ u.
920506	6	1	3,585
920508	8	1	3,673
920510	10	1	3,788

TACO LATÓN

BRASS ANCHOR



Ref. 9250

Pincha QR para ver ficha técnica.



Latón
Brass

Disponible en Autoservicio p. 157.
Available in self-service p. 157.

Referencia	R	Ø Broca (mm)		€ u.
925004	M-4	5	300	0,167
925006	M-6	8	100	0,315
925008	M-8	10	100	0,573
925010	M-10	12	100	1,015
925012	M-12	15	50	2,548

ANCLAJE MACHO

STUD ANCHOR



Ref. 9100

Pincha QR para ver ficha técnica.



Acero cincado
Zinc plated

Referencia	R/L (mm)	Ø ext. (mm)		€ u.
91000645	M-6 x 45	6	150	0,550
91000850	M-8 x 50	8	100	0,628
91000875	M-8 x 75	8	100	0,675
91001070	M-10 x 70	10	100	0,946
91001090	M-10 x 90	10	50	1,028
91001275	M-12 x 75	12	50	1,710
910012110	M-12 x 110	12	50	1,668
910016145	M-16 x 145	16	25	4,683

Debido a nuestro proceso de mejora continua, algunas medidas pueden variar ligeramente.
Due to our continuous improvement process, dimensions may vary.

ANCLAJE CH TORNILLO

SLEEVE ANCHOR CH BOLT

Ref. 9300T

Pincha QR para ver ficha técnica.



Acero cincado
Zinc plated

Referencia	D	R	L (mm)	Ø ext. (mm)		€ u.
930006045T	6 x 45T	M-6	45	8	200	0,385
930006060T	6 x 60T	M-6	60	8	200	0,440
930008060T	8 x 60T	M-8	60	10	100	0,724
930008080T	8 x 80T	M-8	80	10	100	0,881
930010070T	10 x 70T	M-10	70	12	100	1,229
930010100T	10 x 100T	M-10	100	12	50	1,405
930012080T	12 x 80T	M-12	80	16	50	2,033

Disponible en Acero Inox p. 70. / Available in stainless steel p. 70.

ANCLAJE CH ESPÁRRAGO

SLEEVE ANCHOR CH THREADED ROD

Ref. 9300E

Pincha QR para ver ficha técnica.



Acero cincado
Zinc plated

Referencia	D	R	L (mm)	Ø ext. (mm)		€ u.
930006045E	6 x 45E	M-6	45	8	200	0,585
930006060E	6 x 60E	M-6	60	8	200	0,625
930008060E	8 x 60E	M-8	60	10	100	0,917
930010070E	10 x 70E	M-10	70	12	100	1,473

ANCLAJE CH GANCHO

SLEEVE ANCHOR CH HOOK

Ref. 9300G

Pincha QR para ver ficha técnica.



Acero cincado
Zinc plated

Referencia	D	R	L (mm)	Ø ext. (mm)		€ u.
930006045G	6 x 45G	M-6	45	8	100	0,898
930008060G	8 x 60G	M-8	60	10	100	1,524
930010070G	10 x 70G	M-10	70	12	50	2,491

ANCLAJE CH ARGOLLA

SLEEVE ANCHOR CH WITH EYE

Ref. 9300A

Pincha QR para ver ficha técnica.



Acero cincado
Zinc plated

Referencia	D	R	L (mm)	Ø ext. (mm)		€ u.
930006045A	6 x 45A	M-6	45	8	100	0,898
930008060A	8 x 60A	M-8	60	10	100	1,524
930010070A	10 x 70A	M-10	70	12	50	2,491

RESINA DE POLIÉSTER - CARTUCHO

CANISTER



Ref. 9600C

Pincha QR para ver ficha técnica.



Referencia	ml		€ u.
9600C300	300	10	22,000

Utilizable con pistola de silicona.
Usable with canister gun.

Sin estireno
Without styrene

ESPÁRRAGO CON TUERCA Y ARANDELA

THREADED ROD WITH NUT AND WASHER



Acero cincado
Zinc plated

Ref. 9600E

Pincha QR para ver ficha técnica.



Referencia	R/L (mm)		€ u.
9600E08110	M-8 x 110	10	1,638
9600E10130	M-10 x 130	10	4,160
9600E12165	M-12 x 165	10	4,875

En bolsas de 10 unidades
In bags of 10 units

TAMIZ DE PLÁSTICO

PLASTIC SIEVE



Plástico blanco
White plastic

Ref. 9600T

Pincha QR para ver ficha técnica.



Referencia	Ø/L (mm)		€ u.
9600T12060	12 x 60	10	0,317
9600T12080	12 x 80	10	0,333
9600T16085	15 x 85	10	0,336
9600T16130	15 x 130	10	0,366

En bolsas de 10 unidades
In bags of 10 units

PISTOLA CARTUCHO

CANISTER GUN



Ref. 9600P

Pincha QR para ver ficha técnica.



Referencia	D		€ u.
9600P300	300	5	33,475

Pistola válida para cartucho de silicona.
The gun is valid for silicone canister.

MEZCLADOR

MIXER



Plástico blanco
White plastic

Ref. 9600M

Pincha QR para ver ficha técnica.



Referencia	D		€ u.
9600M1	Mezclador	50	0,980

Tacos de plástico y bridas



Ref. 2990 | Pág. 60



Ref. 2980 | Pág. 60



Ref. 2200 | Pág. 61



Ref. 2205 | Pág. 61



Ref. 2202 | Pág. 61



Ref. 2230A | Pág. 61



Ref. 2225 | Pág. 62



Ref. 2225B | Pág. 62



Ref. 2225BEXP1 | Pág. 62



Ref. 2210 | Pág. 63



Ref. 2215 | Pág. 63



Ref. 2230A | Pág. 63



Ref. 9410 | Pág. 64



Ref. 9400 | Pág. 64

BRIDAS NYLON NEGRAS / TACO BRIDA

BLACK NYLON CABLE TIES / CABLE TIES ANCHOR



Ref. 2990

Pincha QR para ver ficha técnica.



**RoHS
REACH
PAHS**



Poliamida
Polyamide



Rápida instalación
Easy installation



Ultravioleta
Ultraviolet

En bolsas de 100 unidades
In bags of 100 units

Las medidas indicadas son aproximadas y pueden variar ligeramente en función de la disponibilidad.
Measures shown are approximate. They may vary depending on availability.

Referencia	M (mm)	Resistencia kg	Ø max (mm)		€ u.
299025098	2,5 x 98	8	20,5	100	0,022
299025135	2,5 x 135	8	30	100	0,030
299025160	2,5 x 160	8	39,8	100	0,039
299036140	3,6 x 140	18	33	100	0,052
299036200	3,6 x 200	18	52,5	100	0,050
299036290	3,6 x 290	18	84	100	0,111
299036370	3,6 x 370	18	106	100	0,134
299045160	4,5 x 160	22	36,6	100	0,075
299048200	4,8 x 200	22	49,5	100	0,064
299048250	4,8 x 250	22	65	100	0,128
299048290	4,8 x 290	22	81	100	0,100
299048360	4,8 x 360	22	100	100	0,183
299048430	4,8 x 430	22	122,5	100	0,236
299076300	7,6 x 300	55	82,8	100	0,285
299076370	7,6 x 370	55	103,5	100	0,347
299076450	7,6 x 450	55	130,5	100	0,384
299076540	7,6 x 540	55	159	100	0,531
299090450	9 x 450	80	130,5	100	0,621
299090780	9 x 780	80	235,5	100	1,155
299090920	9 x 920	80	280	100	1,304
299124650	12,4 x 650	110	195	100	1,446
299124999	12,4 x 1000	110	305	100	2,335
2999TB6N	Taco brida Ø6	-	-	100	0,090
2999TB8N	Taco brida Ø8	-	-	100	0,059

BRIDAS NYLON BLANCAS / TACO BRIDA

WHITE NYLON CABLE TIES



Ref. 2980

Pincha QR para ver ficha técnica.



**RoHS
REACH
PAHS**



Poliamida
Polyamide



Rápida instalación
Easy installation

En bolsas de 100 unidades
In bags of 100 units

Las medidas indicadas son aproximadas y pueden variar ligeramente en función de la disponibilidad.
Measures shown are approximate. They may vary depending on availability.

Referencia	M (mm)	Resistencia kg	Ø max (mm)		€ u.
298025098	2,5 x 98	8	20,5	100	0,022
298025135	2,5 x 135	8	30	100	0,030
298025160	2,5 x 160	8	39,8	100	0,039
298036140	3,6 x 140	18	33	100	0,052
298036200	3,6 x 200	18	52,5	100	0,050
298036290	3,6 x 290	18	84	100	0,111
298036370	3,6 x 370	18	106	100	0,134
298045160	4,5 x 160	22	36,6	100	0,075
298048200	4,8 x 200	22	49,5	100	0,064
298048250	4,8 x 250	22	65	100	0,128
298048290	4,8 x 290	22	81	100	0,100
298048360	4,8 x 360	22	100	100	0,183
298048430	4,8 x 430	22	122,5	100	0,236
298076300	7,6 x 300	55	82,8	100	0,285
298076370	7,6 x 370	55	103,5	100	0,347
298076450	7,6 x 450	55	130,5	100	0,384
298076540	7,6 x 540	55	159	100	0,531
298090450	9 x 450	80	130,5	100	0,621
298090780	9 x 780	80	235,5	100	1,155
298090920	9 x 920	80	280	100	1,304
298124650	12,4 x 650	110	195	100	1,446
298124999	12,4 x 1000	110	305	100	2,335
2999TB8B	Taco brida Ø8	-	-	100	0,098

TACO NYLON

NYLON PLUG



Ref. 2200

Pincha QR para ver ficha técnica.



Ladrillo hueco
Hollow brick



Ladrillo macizo
Massive brick



Hormigón
Concrete

Referencia	Ø/L (mm)		€ u.
220005	5 x 25	200	0,023
220006	6 x 30	100	0,024
220008	8 x 40	100	0,046
220010	10 x 50	50	0,087
220012	12 x 60	25	0,148

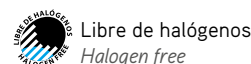

TACO GRIS

GREY PLUG



* Ref. 2205

Pincha QR para ver ficha técnica.



Ladrillo hueco
Hollow brick



Ladrillo macizo
Massive brick



Hormigón
Concrete

Referencia	Ø/L (mm)		€ u.
220506	6 x 30	100	0,017
220508	8 x 40	100	0,026
220510	10 x 50	50	0,068

* Hasta final de existencias. / Until end of stocks.



TACO NYLON CON VALONA

NYLON PLUG WITH RING



Ref. 2202

Pincha QR para ver ficha técnica.



Ladrillo hueco
Hollow brick



Ladrillo macizo
Massive brick



Hormigón
Concrete

Referencia	Ø/L (mm)		€ u.
220206	6 x 30	100	0,026
220208	8 x 40	100	0,050
220210	10 x 50	50	0,094
*220212	12 x 60	25	0,162

* Hasta final de existencias. / Until end of stocks.

Con valona. / With ring.

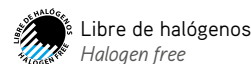

TACO ALAS

NYLON PLUG FOR PLASTERBOARD



Ref. 2230A

Pincha QR para ver ficha técnica.



Ladrillo hueco
Hollow brick



Pladur
Plasterboard

Referencia	Ø/L (mm)		€ u.
2230A1040	10 x 40	100	0,132
2230A1047	10 x 47	100	0,135



TACO PLUSX NYLON

PLUSX PLUG



Ref. 2225

Pincha QR para ver ficha técnica.



Ladrillo hueco
Hollow brick



Ladrillo macizo
Massive brick



Hormigón
Concrete



Pladur
Cardboard

Referencia	Ø/L (mm)		€ u.
222505	5 x 25	200	0,035
222506	6 x 30	100	0,036
222508	8 x 40	100	0,068
222510	10 x 50	50	0,145
222512	12 x 60	25	0,234

Con valona. / With ring.



Poliamida
Polyamide



Ultravioleta
Ultraviolet



Libre de halógenos
Halogen free

BOTE TACO PLUSX NYLON

PLUSX PLUG



Ref. 2225B

Referencia	Ø/L (mm)	u. bote		€ bote
222506B	6 x 30	300	1	13,230
222508B	8 x 40	125	1	11,430
222510B	10 x 50	75	1	13,230



Ladrillo hueco
Hollow brick



Ladrillo macizo
Massive brick



Hormigón
Concrete



Pladur
Cardboard



Poliamida
Polyamide



Ultravioleta
Ultraviolet



Libre de halógenos
Halogen free

CAPACIDAD 48 BOTES

Referencia	Denominación		€ u.
2225BEXP1	Expositor bote taco Plusx vacío sin material	1	190,000

TACO DE PLÁSTICO TRES CORTES

THREE SLOT PLASTIC PLUG



Ladrillo hueco
Hollow brick



Ladrillo macizo
Massive brick



Hormigón
Concrete

Ref. 2210

Pincha QR para ver ficha técnica.



Referencia	Ø/L (mm)		€ u.
221006	6 x 23	1000	0,034
221008	8 x 27	1000	0,042
221009	9 x 30	1000	0,051
221010	10 x 35	1000	0,074
221012	12 x 45	500	0,118

Con valona. / With ring.



Poliétileno
Polyethylene



En bolsas de 25 unidades
In bags of 25 units

TACO DE PLÁSTICO DOS CORTES

TWO SLOT PLASTIC PLUG



Ladrillo hueco
Hollow brick



Ladrillo macizo
Massive brick



Hormigón
Concrete

* Ref. 2215

Pincha QR para ver ficha técnica.



Referencia	Ø/L (mm)		€ u.
221505	5 x 20	1000	0,041
221506	6 x 22	1000	0,027
221508	8 x 25	1000	0,034

* Hasta final de existencias. / Until end of stocks.

Con valona. / With ring.



Poliétileno
Polyethylene



En bolsas de 25 unidades
In bags of 25 units

Disponible en Autoservicio p. 156.
Available in self-service p. 156.

TACO AUTOTALADRANTE PLADUR

PLADUR SELF-DRILLING PLASTIC PLUG



Pladur
Cardboard



Poliamida
Polyamide



Ultravioleta
Ultraviolet



Libre de halógenos
Halogen free

Ref. 2230A

Pincha QR para ver ficha técnica.



Referencia	Ø/L (mm)		€ u.
2230A1538	15 x 38	100	0,159

TACO RÁPIDO M8

M8 FAST PLUG

* Ref. 9410

Pincha QR para ver ficha técnica.



Referencia	R/L (mm)	Broca		€ u.
941008	M-8 x 60	8	50	0,195

* Hasta final de existencias. / Until end of stocks.



Acero zincado
Zinc plated



Poliamida
Polyamide

TACO RÁPIDO

FAST PLUG

Ref. 9400

Pincha QR para ver ficha técnica.



Referencia	Ø/L (mm)	Broca		€ u.
9400535	5 x 35	5	100	0,098
9400545	5 x 45	5	100	0,106
9400640	6 x 40	6	100	0,116
9400645	6 x 45	6	100	0,127
9400655	6 x 55	6	100	0,159
9400660	6 x 60	6	100	0,168
9400680	6 x 80	6	100	0,239
9400845	8 x 45	8	100	0,236
9400860	8 x 60	8	100	0,258
9400880	8 x 80	8	100	0,315



Acero zincado
Zinc plated



Poliamida
Polyamide

Abrazaderas y accesorios en acero inoxidable



Ref. 1409 | Pág. 66



Ref. 1509 | Pág. 66



Ref. 1430 | Pág. 67



Ref. 1903 | Pág. 67



Ref. 9201 | Pág. 67



Ref. 1403 | Pág. 68



Ref. 1503 | Pág. 68



Ref. 1416 | Pág. 69



Ref. 1419 | Pág. 69



Ref. 2104 | Pág. 69



Ref. 2105 | Pág. 70



Ref. 1605 | Pág. 70



Ref. 2923 | Pág. 70



Ref. 2903 | Pág. 70



Ref. 2330 | Pág. 71



Ref. 2913 | Pág. 71



Ref. 9310 | Pág. 71

ABRAZADERA M8 ACERO INOXIDABLE AISI 304

M8 STAINLESS STEEL AISI 304 CLAMP

Ref. 1409

Pincha QR para ver ficha técnica.





Acero inoxidable Aisi 304.
Fleje de 20 x 2 mm hasta Ø160.
De Ø160 en adelante fleje de 28 x 2 (mm).
Stainless steel Aisi 304



Cobre
Copper

Acero
Steel

Plástico
Plastic

Referencia	Ø (mm)	Mini-Máx.	 P"		€ u.
1409018	18	16-20	3/8	50	2,503
1409022	22	21-26	1/2	50	2,674
1409028	28	26-31	3/4	50	2,834
1409035	35	33-38	1"	50	3,002
1409042	40-42	40-45	1" 1/4	50	3,215
1409048	48	47-52	1" 1/2	50	3,446
1409054	54	52-57		50	3,659
1409060	60	60-65	2"	50	3,884
1409075	75	72-77	2" 1/2	50	4,283
1409083	83	81-86		25	5,573
1409090	90	87-94	3"	25	5,692
1409110	110	107-114		25	5,986
1409115	115	114-118	4"	25	6,233
1409125	125	121-128		25	6,537
1409140	140	133-140	5"	25	8,969
1409160	160	158-170	6"	25	9,857
1409200	200	198-210		25	13,607
1409250	250	249-254		25	20,844
1409315	315	314-319		25	26,411

ABRAZADERA ISOFONICA M8 ACERO INOXIDABLE AISI 304

M8 STAINLESS STEEL AISI 304 CLAMP

Ref. 1509

Pincha QR para ver ficha técnica.



Acero inoxidable Aisi 304.
Fleje de 20 x 2 mm hasta Ø160.
De Ø160 en adelante fleje de 28 x 2 (mm).
Stainless steel Aisi 304



Caucho
Rubber





Reducción de sonido
Sound reduction



Cobre
Copper

Acero
Steel

Plástico
Plastic

Referencia	Ø (mm)	Mini-Máx.	 P"		€ u.
1509018	18	16-20	3/8	50	3,665
1509022	22	21-26	1/2	50	3,801
1509028	28	26-31	3/4	50	4,115
1509035	35	33-38	1"	50	4,334
1509040	40	40-46	1" 1/4	25	4,690
1509048	48	47-52	1" 1/2	25	5,132
1509054	54	52-57		25	5,417
1509060	60	50-65	2"	25	5,750
1509075	75	72-77	2" 1/2	25	6,366
1509083	83	81-86		25	7,922
1509090	90	87-94	3"	25	8,080
1509100	100	98-105	3" 1/2	25	8,823
1509110	110	107-114		25	8,919
1509115	115	114-118	4"	25	9,236
1509125	125	121-128		25	9,858
1509140	140	133-140	5"	25	10,972
1509160	160	158-170	6"	25	12,345
1509200	200	198-210		25	15,722
1509250	250	249-254		25	23,636
1509315	315	314-319		25	28,580

Debido a la continua fluctuación en los precios de las materias primas, especialmente acero inoxidable, rogamos confirmen los precios y descuentos ya que los indicados pueden variar.

Due to the continuous fluctuation in the prices of raw material, specially stainless steel, we request you to confirm prices and discounts shown, since they may vary.

ABRAZADERAS Y ACCESORIOS EN ACERO INOXIDABLE HYDRAFIX

ABARCÓN ACERO INOXIDABLE AISI 304



U-BOLT IN STAINLESS STEEL AISI 304

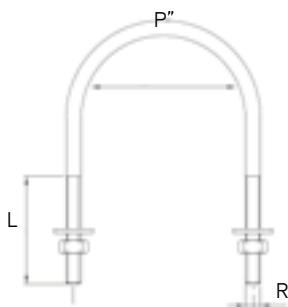

Ref. 1430

Pincha QR para ver ficha técnica.



Referencia	 P"	R	L		€ U.
1430018	3/8	M-6	35	100	2,358
1430022	1/2	M-6	35	100	2,446
1430026	3/4	M-6	35	100	2,600
1430035	1"	M-6	35	100	2,773
1430040	1" 1/4	M-6	35	100	3,015
1430048	1" 1/2	M-8	40	100	5,594
1430060	2"	M-8	40	100	6,229
1430075	2" 1/2	M-8	40	100	6,943
1430090	3"	M-8	40	50	7,561
1430115	4"	M-10	40	50	15,388
1430140	5"	M-10	40	50	18,434
1430160	6"	M-10	40	25	22,143
1430220	8"	M-10	40	25	28,335

Equipado con dos tuercas y dos arandelas.
Available with two nuts and two washers.



Acero inoxidable Aisi 304.
Stainless steel Aisi 304



Acero
Steel

CINTA PERFORADA ACERO INOXIDABLE AISI 430

PERFORATE TAPE STAINLESS STEEL AISI 430



Ref. 1903

Pincha QR para ver ficha técnica.



Referencia	Ancho	Espesor	Perforación (mm)	M/R		€ u.
190317	17	0,7	Ø7	10	1	36,306



Acero inoxidable Aisi 430
Stainless steel Aisi 430



Polipropileno
Polypropylene



Cobre
Copper



Acero
Steel



Plástico
Plastic

ANCLAJE HEMBRA ACERO INOXIDABLE AISI 316

DROP IN ANCHOR IN STAINLESS STEEL AISI 316



Ref. 9201

Pincha QR para ver ficha técnica.



Referencia	R/L (mm)		€ u.
920106	M-6 x 25	50	3,916
920108	M-8 x 30	50	5,582
920110	M-10 x 40	50	8,718



Acero inoxidable Aisi 316
Stainless steel Aisi 316

Debido a la continua fluctuación en los precios de las materias primas, especialmente acero inoxidable, rogamos confirmen los precios y descuentos ya que los indicados pueden variar.

Due to the continuous fluctuation in the prices of raw material, specially stainless steel, we request you to confirm prices and discounts shown, since they may vary.

ABRAZADERA M8 / M8 + M10 ACERO INOXIDABLE AISI 316



M8 / M8 + M10 STAINLESS STEEL AISI 316 CLAMP

Ref. 1403

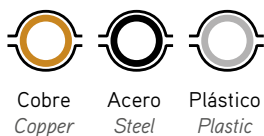
Pincha QR para ver ficha técnica.



Acero inoxidable Aisi 316.
Fleje de 20 x 2 mm hasta Ø160.
De Ø160 en adelante fleje de 28 x 2 (mm).
Stainless steel Aisi 304

Referencia	Ø	Mini.-Máx.	 P"	R		€ u.
1403018	18	16-20	3/8	M-8	50	4,837
1403022	22	21-26	1/2	M-8	50	5,228
1403026	28	26-31	3/4	M-8	50	5,650
1403035	35	33-38	1"	M-8	50	6,026
1403040	40-42	40-45	1" 1/4	M-8	50	6,480
1403048	48	47-50	1" 1/2	M-8	50	6,943
1403054	54	52-57		M-8	50	7,430
1403060	60	60-65	2"	M-8	50	7,831
1403075	75	72-77	2" 1/2	M-8 + M-10	50	9,566
1403090	90	87-94	3"	M-8 + M-10	25	10,295
1403100	100	98-105	3" 1/2	M-8 + M-10	25	14,375
1403110	110	107-114	-	M-8 + M-10	25	14,463
1403115	115	111-118	4"	M-8 + M-10	25	16,337
1403125	125	121-128	-	M-8 + M-10	25	17,020
1403140	140	133-140	5"	M-8 + M-10	25	20,245
1403150	150	147-155		M-8 + M-10	25	21,809
1403160	160	158-170	6"	M-8 + M-10	25	22,590
1403200	200	198-210	-	M-8 + M-10	25	35,503
1403250	250	249-254	-	M-8 + M-10	25	42,268
1403315	315	314-319	-	M-8 + M-10	25	50,763

ABRAZADERA ISOFONICA M8 + M10 ACERO INOXIDABLE AISI 316

M8 + M10 STAINLESS STEEL AISI 316 CLAMP WITH RUBBER

Ref. 1503

Pincha QR para ver ficha técnica.





Acero inoxidable Aisi 316.
Fleje de 20 x 2 mm hasta Ø160.
De Ø160 en adelante fleje de 28 x 2 (mm).
Stainless steel Aisi 304



Caucho
Rubber



Reducción de sonido
Sound reduction

Referencia	Ø	Mini.-Máx.	 P"	R		€ u.
1503018	18	16-20	3/8	M-8 + M-10	50	6,615
1503022	22	21-26	1/2	M-8 + M-10	50	7,068
1503026	26	26-31	3/4	M-8 + M-10	50	7,467
1503035	35	33-38	1"	M-8 + M-10	50	8,048
1503040	40	40-45	1" 1/4	M-8 + M-10	25	8,688
1503048	48	47-52	1" 1/2	M-8 + M-10	25	9,333
1503054	54	52-57		M-8 + M-10	25	9,865
1503060	60	60-65	2"	M-8 + M-10	25	10,390
1503075	75	72-77	2" 1/2	M-8 + M-10	25	11,655
1503090	90	87-94	3"	M-8 + M-10	25	12,440
1503110	110	107-114		M-8 + M-10	25	14,119
1503115	115	111-118	4"	M-8 + M-10	25	14,463
1503125	125	121-128		M-8 + M-10	25	15,428
1503140	140	133-140	5"	M-8 + M-10	25	17,758
1503150	150	147-155		M-8 + M-10	25	19,354
1503160	160	158-170	6"	M-8 + M-10	25	20,060
1503200	200	198-210		M-8 + M-10	25	28,592
1503250	250	249-254		M-8 + M-10	25	33,997

Debido a la continua fluctuación en los precios de las materias primas, especialmente acero inoxidable, rogamos confirmen los precios y descuentos ya que los indicados pueden variar.

Due to the continuous fluctuation in the prices of raw material, specially stainless steel, we request you to confirm prices and discounts shown, since they may vary.

ABRAZADERAS Y ACCESORIOS EN ACERO INOXIDABLE HYDRAFIX

ABRAZADERA M6 ACERO INOXIDABLE AISI 304

M6 STAINLESS STEEL AISI 304 CLAMP



Ref. 1416

Pincha QR para ver ficha técnica.



Referencia	Ø (mm)	P"	Mini-Máx.		€ u.
1416012	12	1/4	10-13	100	2,628
1416015	15		14-17	100	2,675
1416018	18	3/8	17-20	100	2,722
1416020	20		19-22	100	2,789
1416022	22	1/2	21-24	100	2,812
1416025	25		23-27	100	2,905
1416028	28	3/4	25-29	100	2,970
1416032	32		29-33	100	3,101
1416035	35	1"	34-38	100	3,210



Acero inoxidable Aisi 304. Fleje de 16 x 1,5 mm
Stainless steel Aisi 304

ABRAZADERA M6 HYDRATUBE INOX AISI 304

STAINLESS STEEL AISI 304 HYDRATUBE CLAMP



Ref. 1419

Pincha QR para ver ficha técnica.

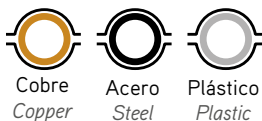

Referencia	Ø (mm)		€ u.
141915	15	90	3,057
141918	18	60	3,286
141922	22	40	4,432
141928	28	20	5,518



Acero inoxidable Aisi 304
Stainless steel Aisi 304

TIRAFONDO ABRAZADERA ACERO INOXIDABLE AISI 304

CONNECTING SCREW IN STAINLESS STEEL AISI 304



Ref. 2104

Pincha QR para ver ficha técnica.



Acero inoxidable Aisi 304
Stainless steel Aisi 304

Referencia	R/L (mm)		€ u.
2104630	M-6 x 30	100	0,826
2104640	M-6 x 40	100	0,858
2104850	M-8 x 50	100	1,692

Sin ranura

Debido a la continua fluctuación en los precios de las materias primas, especialmente acero inoxidable, rogamos confirmen los precios y descuentos ya que los indicados pueden variar.

Due to the continuous fluctuation in the prices of raw material, specially stainless steel, we request you to confirm prices and discounts shown, since they may vary.

TIRAFONDO DOBLE ROSCA (DOWELL) ACERO INOXIDABLE AISI 304

DOUBLE THREAD SCREW IN STAINLESS STEEL AISI 304



Ref. 2105

Pincha QR para ver ficha técnica.



 Acero inoxidable Aisi 304
Stainless steel Aisi 304



Referencia	R/L (mm)		€ u.
21050850	M-8 x 50	100	2,692
21050860	M-8 x 60	100	2,800
21050880	M-8 x 80	100	3,571
210508100	M-8 x 100	100	4,433
210510100	M-10 x 100	100	7,232

ABRAZADERA SIN FIN ACERO INOXIDABLE AISI 304 CON TORNILLO INOXIDABLE

GERMAN TYPE HOSE STAINLESS STEEL AISI 304



Ref. 1605

Pincha QR para ver ficha técnica.



 Acero inoxidable Aisi 304 (banda, soporte y tornillo)
Stainless steel Aisi 304 (band, case and screw)



Referencia	Ø (mm)		€ u.
1605008	8-12	200	1,156
1605010	10-16	200	1,178
1605012	12-20	200	1,200
1605016	16-25	200	1,222
1605020	20-32	200	1,398
1605025	25-40	100	1,441
1605040	40-60	50	1,548
1605050	50-70	50	1,658
1605070	70-90	50	1,984
1605080	80-100	25	2,080
1605090	90-110	25	2,152
1605100	100-120	25	2,247
1605110	110-130	25	2,319

Ancho 9 mm. Espesor 0,6. Tornillo M6. Otras medidas consultar.
Width 9 mm. Thickness 0.6. Screw M6. Other measures please consult.

ARANDELA PLANA ACERO INOXIDABLE AISI 304

FLAT WASHER IN STAINLESS STEEL AISI 304



Ref. 2923

Pincha QR para ver ficha técnica.



 Acero inoxidable Aisi 304
Stainless steel Aisi 304



Referencia	Ø (mm)	Ø exterior		€ u.
292306	6	12	200	0,043
292308	8	16	200	0,066
292310	10	20	200	0,138
292312	12	24	200	0,287
292316	16	30	100	0,462

ANCLAJE CH TORNILLO ACERO INOXIDABLE AISI 304

BOLT SLEEVE ANCHOR STAINLESS STEEL AISI 304



Ref. 9310

Pincha QR para ver ficha técnica.



 Acero inoxidable Aisi 304
Stainless steel Aisi 304



Referencia	D	R	Ø ext. (mm)		€ u.
93100645T	6 x 45T	M-6	8	20	2,077
93100660T	6 x 60T	M-6	8	20	2,333
93100860T	8 x 60T	M-8	10	20	3,281
93100880T	8 x 80T	M-8	10	20	4,399
93101070T	10 x 70T	M-10	12	10	5,929
93101099T	10 x 100T	M-10	12	10	9,086
93101280T	12 x 80T	M-12	16	10	11,715

Debido a la continua fluctuación en los precios de las materias primas, especialmente acero inoxidable, rogamos confirmen los precios y descuentos ya que los indicados pueden variar.

Due to the continuous fluctuation in the prices of raw material, specially stainless steel, we request you to confirm prices and discounts shown, since they may vary.

VARILLA ROSCADA ACERO INOXIDABLE AISI 304

THREADED ROD IN STAINLESS STEEL AISI 304



 Acero inoxidable Aisi 304
Stainless steel Aisi 304

Ref. 2903

Pincha QR para ver ficha técnica.



Referencia	R/L (mm)		€ u.
290306	M-6 x 1000	25	7,917
290308	M-8 x 1000	10	10,241
290310	M-10 x 1000	10	19,244
290312	M-12 x 1000	8	26,856
290316	M-16 x 1000	6	49,268

MANGUITO HEXAGONAL ACERO INOXIDABLE AISI 304

HEXAGONAL SPACER IN STAINLESS STEEL AISI 304



 Acero inoxidable Aisi 304
Stainless steel Aisi 304

Ref. 2330

Pincha QR para ver ficha técnica.



Referencia	R/L (mm)		€ u.
2330625	M-6 x 25	100	3,015
2330825	M-8 x 25	100	3,911
23301030	M-10 x 30	100	5,838

TUERCA HEXAGONAL ACERO INOXIDABLE AISI 304

HEXAGONAL NUT IN STAINLESS STEEL AISI 304



 Acero inoxidable Aisi 304
Stainless steel Aisi 304

Ref. 2913

Pincha QR para ver ficha técnica.



Referencia	R		€ u.
291306	M-6	300	0,093
291308	M-8	200	0,171
291310	M-10	200	0,409
291312	M-12	200	0,596
291316	M-16	100	1,096

Debido a la continua fluctuación en los precios de las materias primas, especialmente acero inoxidable, rogamos confirmen los precios y descuentos ya que los indicados pueden variar.

Due to the continuous fluctuation in the prices of raw material, specially stainless steel, we request you to confirm prices and discounts shown, since they may vary.

Soportación



Ref. 1300GM | Pág. 73



Ref. 1333GM | Pág. 73



Ref. 1590G | Pág. 73



Ref. 1590S | Pág. 74



Ref. 1590 | Pág. 73



Ref. 1940 | Pág. 73



Ref. 1590S | Pág. 74



Ref. 1590S | Pág. 75



Ref. 1590E | Pág. 75



Ref. 1590SH | Pág. 76



Ref. 1590SV | Pág. 76



Ref. 1590SAH | Pág. 76



Ref. 1590M | Pág. 77



Ref. 1590MCH | Pág. 77



Ref. 1590TG | Pág. 78



Ref. 1590TG | Pág. 78



Ref. 1590TGR | Pág. 78



Ref. 1590TU | Pág. 78



Ref. 1590TSR | Pág. 79



Ref. 1590TR | Pág. 79



Ref. 1590TM | Pág. 79

GUÍAS METÁLICAS

RAILS

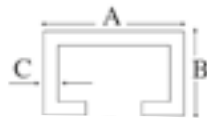

Ref. 1300GM

Pincha QR para ver ficha técnica.



Referencia	M (A-B-C) (mm)	Longitud			€ u.
1300GM	25 x 7,5 x 0,8	1 m	10	2200	6,337

Ref. 1333GM

Pincha QR para ver ficha técnica.



Referencia	M (A-B-C) (mm)	Longitud			€ u.
1333GM2	20 x 10 x 1	2 m	30	1200	6,496

Ref. 1590G

Pincha QR para ver ficha técnica.



Referencia	M (A-B-C) (mm)	Longitud			€ u.
1590G2718	27 x 18 x 1,25	2 m	12	576	9,677
1590G2830	28 x 30 x 1,75	2 m	8	352	20,064
1590G3840	38 x 40 x 2	2 m	4	192	30,330
1590G4020	40 x 20 x 1,5	2 m	10	560	16,062



Acero sendzimir (EN10346)
Zinc plated

Otras medidas consultar.
Other measures, please consult.

GUÍA METÁLICA STRUT

STRUT RAIL



2 metros - Ref. 1590G

Pincha QR para ver ficha técnica.



Referencia	M (A-B-C) (mm)	Longitud			€ u.
1590G42120	41 x 21 x 2	2 m	4	210	32,400
1590G44125	41 x 41 x 2,5	2 m	4	120	38,377

3 metros - Ref. 1590G

Referencia	M (A-B-C) (mm)	Longitud			€ u.
1590G41253	41 x 41 x 2,5	3 m	1	120	73,388



Acero sendzimir (EN10346)
Zinc plated

TORNILLO CARRIL M6 X 10

M6 RAIL SCREW M6 X 10

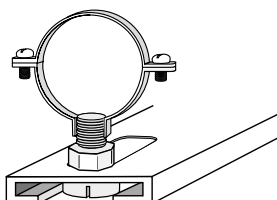

Ref. 1940

Pincha QR para ver ficha técnica.



Referencia	R/L (mm)		€ u.
1940610	M-6 x 10	500	0,093

Especial montantes. Para guías 25 x 7,5 x 0,8 y 20 x 10 x 1.
Válido también para grapa puente.
Screw for rails 25 x 7,5 x 0,8 and 20 x 10 x 1.
Valid for "U" type clip.



Acero cincado
Zinc plated

SOPORTES

SUPPORT



Ref. 1590S

Pincha QR para ver ficha técnica.



Referencia	Dimensiones (mm) A x B x C	L (mm)		€ u.
1590S200	27 x 18 x 1,25	200	25	4,957
1590S300	27 x 18 x 1,25	300	25	5,770

Acero cincado
Zinc plated

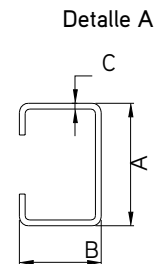
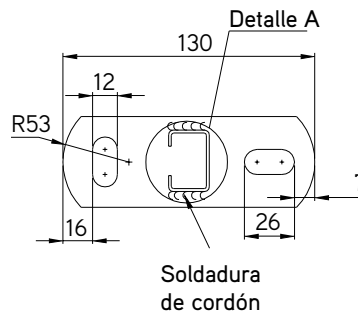
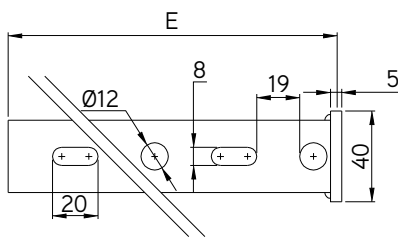

Ref. 1590S

Pincha QR para ver ficha técnica.



Referencia	Dimensiones (mm) A x B x C	L (mm)		€ u.
1590S38200	38 x 40 x 2	200	10	10,167
1590S38300	38 x 40 x 2	300	10	11,493
1590S38400	38 x 40 x 2	400	10	13,998
1590S38600	38 x 40 x 2	600	1	21,881
1590S38800	38 x 40 x 2	800	1	28,526
1590S38999	38 x 40 x 2	1000	1	31,385

Acero cincado
Zinc plated

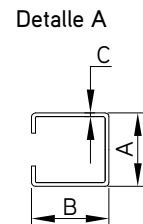
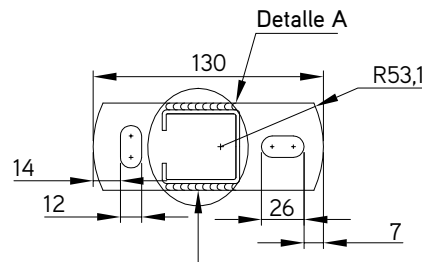
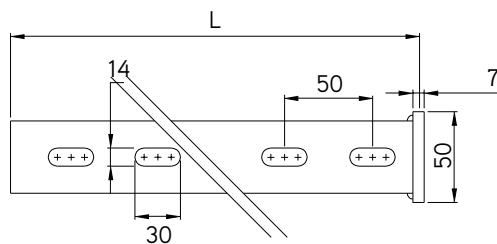

Debido a nuestro proceso de mejora continua, algunas medidas pueden variar ligeramente.
Due to our continuous improvement process, dimensions may vary.

SOPORTES

SUPPORT



Ref. 1590S

Pincha QR para ver ficha técnica.



Referencia	Dimensiones (mm) A x B x C	L (mm)		€ u.
1590S41200	41 x 41 x 2,5	200	10	11,346
1590S41300	41 x 41 x 2,5	300	10	14,882
1590S41400	41 x 41 x 2,5	400	10	18,713
1590S41600	41 x 41 x 2,5	600	1	23,723
1590S41800	41 x 41 x 2,5	800	1	35,820
1590S41999	41 x 41 x 2,5	1000	1	41,493

Acero cincado
Zinc plated

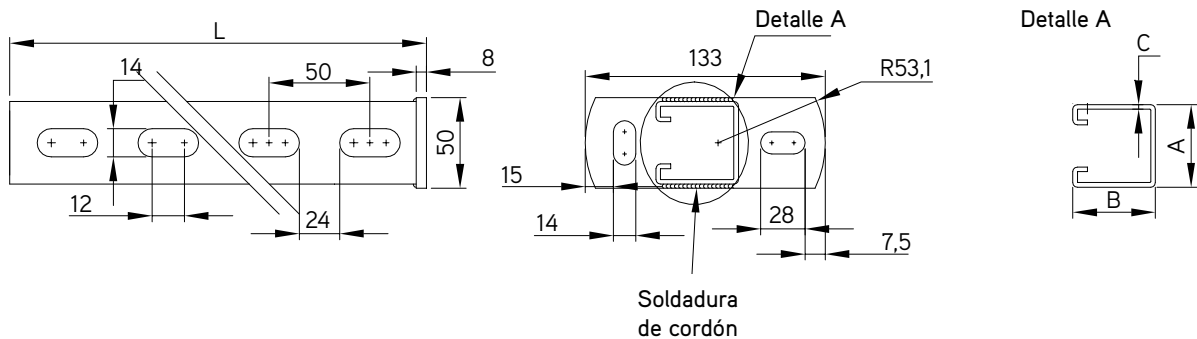

ESCUADRA 90°

90° BRACKET



Ref. 1590E

Pincha QR para ver ficha técnica.

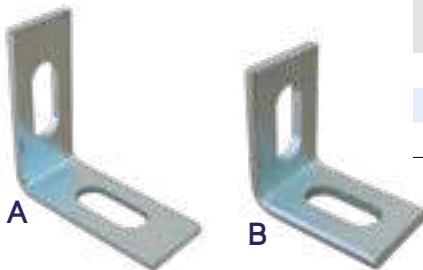

Referencia	M		€ u.
1590E9027	(A) 27-18, 28-30	100	1,933
1590E9038	(A) 38-40	25	4,178
1590E9041	(B) 40 x 20, STRUT 41 x 41 y 41 x 21	100	7,415

Acero cincado
Zinc plated

ESCUADRA 135°

135° BRACKET



Ref. 1590E

Pincha QR para ver ficha técnica.



Referencia	M		€ u.
1590E13527	27-18, 28-30 y 38-40	100	1,934
1590E13541	40 x 20, STRUT 41 x 41 y 41 x 21	100	7,415

Acero cincado
Zinc plated

SOPORTE HORIZONTAL

HORIZONTAL SUPPORT

Pincha QR para ver ficha técnica.



Ref. 1590SH

Referencia	M		€ u.
1590SH27	27-18 y 28-30	25	6,769
1590SH38	38-40, 40-20 y 41-41 STRUT	25	8,122

Acero cincado
Zinc plated

SOPORTE VERTICAL

VERTICAL SUPPORT

Pincha QR para ver ficha técnica.



Ref. 1590SV

Referencia	M		€ u.
1590SV27	27-18 y 28-30	25	5,375
1590SV38	38-40 y 40-20	25	8,886

Acero cincado
Zinc plated

SOPORTE APOYO HORIZONTAL

HORIZONTAL PROP SUPPORT

Pincha QR para ver ficha técnica.



Ref. 1590SAH

Referencia	M		€ u.
1590SAH27	27-18 y 28-30	10	7,122
1590SAH38	38-40 y 40-20	10	18,602

Acero cincado
Zinc plated

MORDAZA PARA VIGA FUNDICIÓN

BEAM CLAMP FM AND VDS APPROVED

Pincha QR para ver ficha técnica.



R
Rosca métrica

Fundición de hierro galvanizado
Galvanised cast iron



Ref. 1590M

Referencia	R	Carga máxima recomendada (Kg)		€ u.
1590M08	M8	120	50	3,536
1590M10	M10	250	50	4,049
1590M12	M12	350	50	7,382

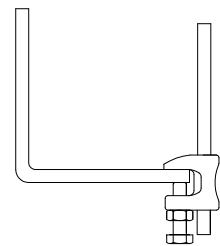
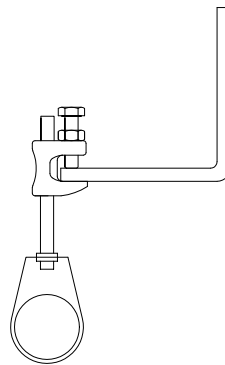
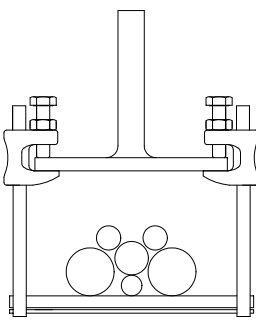

MORDAZA PARA VIGA CHAPA

BEAM CLAMP FM AND VDS APPROVED

Pincha QR para ver ficha técnica.



R
Rosca métrica

Acero cincado
Zinc plated



Solo M10
Only M10

Ref. 1590MCH

Referencia	R	Carga máxima recomendada (Kg)		€ u.
1590MCH08	M8	120	100	2,902
1590MCH10	M10	250	50	3,856

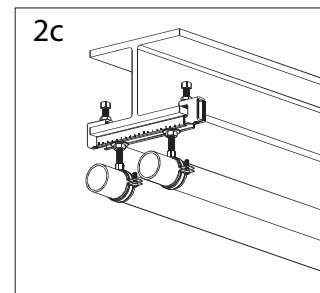
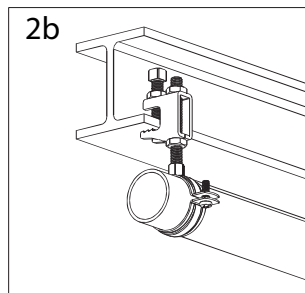
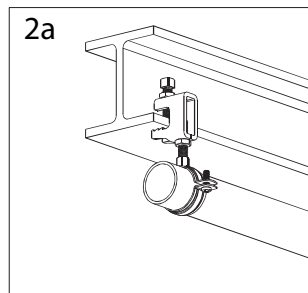
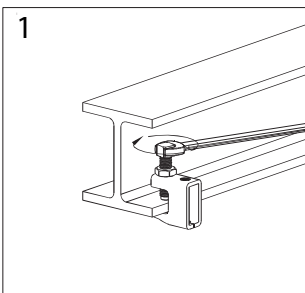

TORNILLO GUÍA 27-18 Y 28-30

BOLT FOR RAIL 27-18 AND 28-30



Ref. 1590TG

Pincha QR para ver ficha técnica.



Referencia	R/L (mm)		€ u.
1590TG6	M-6 x 20	100	0,815
1590TG820	M-8 x 20	100	1,041
1590TG830	M-8 x 30	50	1,211



TORNILLO GUÍA 38-40 Y 40-20

BOLT FOR RAIL 38-40 AND 40-20



Ref. 1590TG

Pincha QR para ver ficha técnica.



Referencia	R/L (mm)		€ u.
1590TG0838	M-8 x 30	100	1,963
1590TG1038	M-10 x 30	100	2,194



TORNILLO GUÍA STRUT 41 X 41

STRUT BOLT FOR RAIL 41 X 41



Ref. 1590TG

Pincha QR para ver ficha técnica.



Referencia	R/L (mm)		€ u.
1590TG840	M-8 x 40	100	2,827
1590TG1040	M-10 x 40	100	3,377



TORNILLO GUÍA RÁPIDO 27-18 Y 28-30

FAST BOLT FOR RAIL 27-18 AND 28-30



Ref. 1590TGR

Pincha QR para ver ficha técnica.



Referencia	R/L (mm)		€ u.
1590TGR830	M-8 x 30	100	3,678



TUERCA GUÍA 27-18, 28-30 Y 38-40

NUT FOR RAIL



Ref. 1590TU

Pincha QR para ver ficha técnica.



Referencia	R		€ u.
1590TU0827	M-8	100	0,374
1590TU1027	M-10	100	0,374



TUERCA GUÍA STRUT FIJACIÓN RÁPIDA

NUT WITH PLASTIC FIXATION FOR STRUT RAIL



Ref. 1590TSR

Pincha QR para ver ficha técnica.



Referencia	R		€ u.
1590TSR06	M-6	100	1,159
1590TSR08	M-8	100	1,189
1590TSR10	M-10	100	1,276
1590TSR12	M-12	100	1,279

Acero cincado
Zinc plated

Para carriles 41x...

- Ahorro en costes de almacenamiento.
- Perfecto para la instalación vertical: se queda donde debe estar. Aprieta el canal, pero se mantiene móvil.
- No se engancha en los canales ranurados.
- Ensamblaje rápido y fácil con una sola mano. Con un cuarto de vuelta.

Color: Color estándar del retén de plástico gris. Otros colores bajo demanda.



TUERCA GUÍA STRUT 41 X 41

NUT FOR RAIL



Ref. 1590TR

Pincha QR para ver ficha técnica.



Acero cincado
Zinc plated

Referencia	M		€ u.
1590TR4108	M-8	100	0,675
1590TR4110	M-10	100	0,800
1590TR4112	M-12	100	0,978

TUERCA GUÍA STRUT CON MUELLE 41 X 41

NUT FOR RAIL



*Ref. 1590TM

Pincha QR para ver ficha técnica.



Acero cincado
Zinc plated

Referencia	M		€ u.
1590TM4108	M-8 muelle 40	100	0,562
1590TM4110	M-10 muelle 40	100	0,900
1590TM4112	M-12 muelle 40	100	1,015

* Hasta final de existencias. / Until end of stocks.

Intumescente

Protección pasiva contra incendios



Ref. 22600 | Pág. 81



Ref. 22200 | Pág. 81



Ref. 92100 | Pág. 81



Ref. 22300 | Pág. 82



Ref. 3250 | Pág. 82



Ref. AFB | Pág. 82



Ref. AFG | Pág. 83



Ref. AFL | Pág. 83



Ref. AFG | Pág. 84



Ref. AFG3 | Pág. 85



Ref. AFG300MC | Pág. 86

COLLARÍN INTUMESCENTE HN

INTUMESCENT COLLAR HN

Pincha QR para ver ficha técnica.



Ref. 22600

Referencia	Ø (mm)		€ u.
22600110	110	1	46,865
22600125	125	1	68,541
22600160	160	1	96,320



Exterior Acero. Pintura epoxi rojo
Steel epoxi paint red



Interior intumescente grafito
Internal intumescent graphite

El Intumescente inicia la expansión a partir de los 180º C de temperatura.
The intumescent starts expansion from 180º of temperature.

APLICACIONES:

Tubería combustible (PVC, PP, PE, ABS y multicapa).
Tubería combustible PPR.

CERTIFICACIONES:

Clase EI 240 (UNE EN 1366-3) Forjado de hormigón.
Clase EI 180 (UNE EN 1366-3) Pared flexible o rígida.
Las resistencias pueden variar según el material de la tubería.

ETA 21/0534

COLLARÍN INTUMESCENTE HV

INTUMESCENT COLLAR HV

Pincha QR para ver ficha técnica.



* Ref. 22200

Referencia	Ø (mm)		€ u.
22200160	160	1	61,000

* Hasta final de existencias. / Until end of stocks.

CERTIFICACIONES:

Clase EI 180 (UNE EN 1366-3) Forjado de hormigón.
Informe de clasificación: Nº IC130019 de fecha 31-10-2013.



Exterior Acero. Pintura epoxi rojo
Steel epoxi paint red



Interior intumescente grafito
Internal intumescent graphite

ANCLAJE CUÑA

WEDGE ANCHOR

Pincha QR para ver ficha técnica.

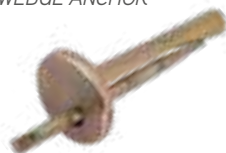

Ref. 92100

Referencia	Denominación	Longitud	Broca		€ u.
92100640	Anclaje cuña 6 x 40	40	Ø6	100	0,333

Anclaje para hormigón y materiales similares. No admite desmontaje.
Anchor for concrete and similar materials. Can not be dismantled.

COLLARÍN INTUMESCENTE HC

INTUMESCENT BAND HC



* Ref. 22300

Pincha QR para ver ficha técnica.



Referencia	Ø Interior (mm)	Ø Exterior (mm)	Altura (mm)	Espesor intum. (mm)	Resist. al Fuego		€ u.
22300032	32	44	65	4	EI 120	1	22,000
22300075	75	85	65	8	EI 240	1	34,000
22300082	82	103	65	8	EI 240	1	42,000

* Hasta final de existencias. / Until end of stocks.

Otras medidas consultar. / Ask for special measures.

Según Norma EN 1366-3

El Intumescente inicia la expansión a partir de los 180º C de temperatura.

The intumescent starts expansion from 180º of temperature.



Exterior Acero. Pintura epoxi rojo
Steel epoxi paint red



Interior intumescente grafito
Internal intumescent graphite

REJILLA INTUMESCENTE RF 120

INTUMESCENT GRATINGS RF 120



Ref. 3250

Pincha QR para ver ficha técnica.



Referencia	M (mm)	Resistencia al Fuego		€ u.
3250150150	150 x 150	EI 120	1	208,905
3250150300	150 x 300	EI 120	1	334,590
3250200200	200 x 200	EI 120	1	266,190
3250200400	200 x 400	EI 120	1	438,425
3250300300	300 x 300	EI 120	1	446,025
3250300400	300 x 400	EI 120	1	578,265
3250400400	400 x 400	EI 120	1	718,675



Silicato sódico forrado de PVC
PVC coated sodium silicate

Con tratamiento antimicrobial integral
Treatment comprehensive antimicrobial.

Bajo pedido.
Upon request.

Características: Según norma UNE EN 1364-5: 2017.

Aplicación: Las rejillas cortafuegos permiten la ventilación a través de los diferentes elementos de compartimentación cortafuegos, como puertas, paredes, mamparas, techos, etc. La reacción de expansión empieza en temperaturas entre 120º y 150º dependiendo de su composición (silicato sódico, grafito forrado, etc).

Technical characteristics: In accordance with Norm EN 1364-5: 2017.

Use: FR 120 gratings allow ventilation through the different FR compartment elements such us doors, walls, ceilings, partitions, etc. Expanding reaction starts with temperatures between 120º and 150º depending on composition (sodium silicate, covered graphite, etc.)

SAQUITO INTUMESCENTE

INTUMESCENT PILLOW



Ref. AFB

Pincha QR para ver ficha técnica.



Referencia	M (mm)		€ u.
AFB10A	120 x 100 x 25	1	30,418
AFB15A	120 x 150 x 30	1	33,634
AFB20A	120 x 200 x 30	1	36,984
AFB25A	120 x 250 x 35	1	44,354
AFB30A	120 x 300 x 35	1	54,203



Bolsa de fibra de vidrio incombustible
Non combustible fibreglass bag



Grafito intumescente + silicatos
Intumescent graphite + silicates

Otros productos intumescentes consultar.
Other intumescent products please consult.

CERTIFICACIONES:

Clase EI 120 (UNE EN 1366-3) Tabique autoportante cartón-yeso.
Clase EI 120 (UNE EN 1366-3) Pared sándwich.



ETA 16/0733

COLLARÍN INTUMESCENTE EN "C" ACERO INOXIDABLE

INTUMESCENT BAND STAINLESS STEEL AISI 304

Pincha QR para ver ficha técnica.



CERTIFICACIONES:

Clase EI 180 (UNE EN 1366-3) Forjado de hormigón.
 Clase EI 180 (UNE EN 1366-3) Pared de hormigón celular.
 Clase EI 120 (UNE EN 1366-3) Pared de cartón-yeso.

 ETA 16/0772 (excepto ref. AFG10IC)

Ref. AFG-C

Referencia	Ø tubo (mm)	exterior (mm)	Altura (mm)	Espesor intumescente (mm)	Puntos de fijacion		€ u.
AFG51FC	< 110	150x150	51	16	4	1	268,632
AFG51HCH7	110 - 160	222x222	75	24	6	1	458,640
AFG10IC	160 - 200	380x285	110	24	6	1	744,111
AFG10LC	200 - 250	355x355	100	40	6	1	1,454,544
*AFG400	250 - 400	536x536	150	56	8	1	2.669,436

 Exterior Acero inoxidable AISI 430
 Stainless steel AISI 430

 Interior intumescente grafito
 Internal intumescent graphite

El Intumescente inicia la expansión a partir de los 180° C de temperatura.

The intumescent starts expansion from 180° of temperature.



* Solución con collarín cuadrado.

LADRILLO INTUMESCENTE

INTUMESCENT BRICK

Ref. AFL

Pincha QR para ver ficha técnica.



Referencia	M (mm)		€ u.
AFL15A	150 x 150 x50	12	58,175

 Poliuretano + material intumescente
 Polyurethane + intumescent material

CERTIFICACIONES:

Clase EI 120 (UNE EN 1366-3) Forjado de hormigón.
 Clase EI 120 (UNE EN 1366-3) Pared de hormigón celular.
 Clase EI 120 (UNE EN 1366-3) Pared de cartón-yeso.

COLLARÍN INTUMESCENTE ACERO INOXIDABLE

INTUMESCENT COLLAR

Pincha QR para ver ficha técnica.



CERTIFICACIONES:

- Clase EI 180 (UNE EN 1366-3) Forjado de hormigón ligero.
- Clase EI 120 (UNE EN 1366-3) Pared de hormigón celular.
- Clase EI 120 (UNE EN 1366-3) Pared de cartón-yeso.
- Clase EI 120 (UNE EN 1366-3) Tabique autoportante cartón-yeso.
- Clase EI 120 (UNE EN 1366-3) Pared sándwich.
- Clase EI 120 (UNE EN 1365-2) Falso techo de fibra.



Ref. AFG

Referencia	Ø tubo (mm)	Ø exterior (mm)	Altura (mm)	Espesor intumescente (mm)	Puntos de fijacion		€ u.
AFG31M	30	52	50	8	4	1	33,623
AFG31A	40	62	50	8	4	1	39,587
AFG51B	50	72	50	8	4	1	46,482
AFG51C	63	85	50	8	4	1	50,689
AFG51D	80	102	50	8	4	1	53,416
AFG51E	90	112	50	8	4	1	51,671
*AFG51O	100	122	50	8	4	1	58,872
AFG51F	110	132	50	8	4	1	55,361
AFG51G	125	155	70	12	4	1	84,749
*AFG51N	140	170	70	12	5	1	102,419
AFG51H	160	190	70	12	5	1	113,704
AFG10I	200	252	100	20	5	1	254,014
AFG10L	250	302	100	20	5	1	273,829
AFG20P	315	375	200	24	5	1	882,450

* Solo bajo demanda. / Only available on request.



Exterior Acero inoxidable AISI 430
Stainless steel AISI 430



Interior intumescente grafito
Internal intumescent graphite

El Intumescente inicia la expansión a partir de los 180º C de temperatura.

The intumescent starts expansion from 180º of temperature.

APLICACIONES:

- Tubería combustible (PVC, PP, PE, ABS y multicapa).
- Tubería combustible con inclinación de hasta 45º.
- Tubería combustible con cables eléctricos.
- Tubería metálica con aislamiento combustible.

APPLICATIONS:

- Combustible pipes (PVC, PP, PE, ABS and PAP).
- Combustible pipe with max. inclination of 45º.
- Combustible pipes containing electric cables.
- Insulated metal pipes.



COLLARÍN INTUMESCENTE ACERO INOXIDABLE B3

INTUMESCENT COLLAR

Pincha QR para ver ficha técnica.



CERTIFICACIONES:

- Clase EI 180 (UNE EN 1366-3) Forjado de hormigón ligero.
- Clase EI 120 (UNE EN 1366-3) Pared de hormigón celular.
- Clase EI 120 (UNE EN 1366-3) Pared de cartón-yeso.
- Clase EI 120 (UNE EN 1366-3) Tabique autoportante cartón-yeso.
- Clase EI 120 (UNE EN 1366-3) Pared sándwich.
- Clase EI 120 (UNE EN 1365-2) Falso techo de fibra.



Ref. AFG3

Referencia	Ø tubo (mm)	Ø exterior (mm)	Altura (mm)	Espesor intumescente (mm)	Puntos de fijación		€ u.
AFG31MB	30	52	30	8	4	1	34,595
AFG31AB	40	62	30	8	4	1	40,722
AFG31D	80	118	30	16	4	1	60,746
AFG31E	90	128	30	16	4	1	62,647
AFG31F	110	148	30	16	4	1	69,092



Exterior Acero inoxidable AISI 430
Stainless steel AISI 430



Interior intumescente grafito
Internal intumescent graphite

El Intumescente inicia la expansión a partir de los 180° C de temperatura.

The intumescent starts expansion from 180° of temperature.



ALTURA 3 CM

APLICACIONES:

- Tubería combustible (PVC, PP, PE, ABS y multicapa).
- Tubería combustible con inclinación de hasta 45°.
- Tubería combustible con cables eléctricos.
- Tubería metálica con aislamiento combustible.
- Espacios reducidos.

APPLICATIONS:

- Combustible pipes (PVC, PP, PE, ABS and PAP).*
- Combustible pipe with max. inclination of 45°.*
- Combustible pipes containing electric cables.*
- Insulated metal pipes.*
- Tight spaces.*

MULTICOLLARÍN INTUMESCENTE ACERO INOXIDABLE

INTUMESCENT BAND STAINLESS STEEL AISI 304

Pincha QR para ver ficha técnica.



Ref. AFG300MC



Referencia	Denominación		€ u.
AFG300MC	Multicollar intumescente	1	409,590

CERTIFICACIONES:

- Clase EI 120 (UNE EN 1366-3) Pared de cartón-yeso.
- Clase EI 180 (UNE EN 1366-3) Forjado y pared de hormigón celular.
- Clase EI 120 (UNE EN 1366-3) Tabique autoportante cartón-yeso.
- Clase EI 120 (UNE EN 1365-2) Pared sándwich.



Acero Inox. Aisi 430
Stainless steel Aisi 430



Interior intumescente grafito
Internal intumescent graphite.

Ø Tubería	Longitud de la banda metálica (mm)	Longitud de la banda intumescente (mm)	Nº de vueltas	Nº de collarines obtenibles	Nº puntos de fijación
Ø30	200	240	2	15	4
Ø40	230	310	2	13	4
Ø50	260	380	2	11	4
Ø63	300	460	2	10	4
Ø80	350	560	2	8	4
Ø90	380	620	2	7	4
Ø100	410	680	2	7	4
Ø110	440	750	2	6	4
Ø125	515	1310	3	5	5
Ø140	560	1450	3	5	5
Ø160	620	1640	3	4	5
Ø200*	2x795	2x3500	5	1	5
Ø250*	2x955	2x4300	5	1	5
Ø315*	2x1200	2x6430	6	0.5	5

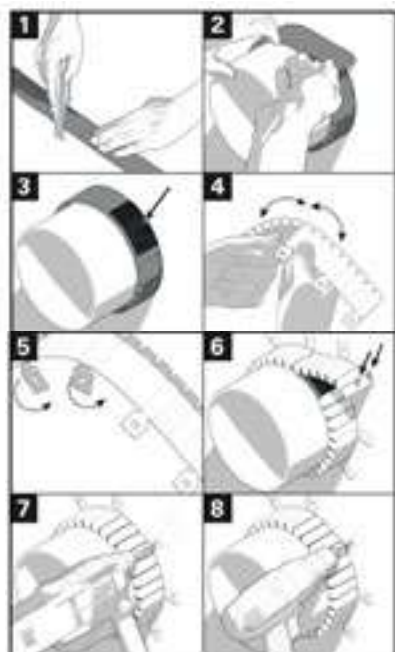

INSTRUCCIONES DE MONTAJE:

- 1- Cortar la banda intumescente a la medida indicada en la tabla.
- 2- Envolver la banda intumescente alrededor del tubo.
- 3- Fijar con una cinta adhesiva.
- 4- Romper la chapa de acero doblandola a lo largo del moleteado.
- 5- Doblar hacia fuera la alas perimetrales de fijación.
- 6- Envolver la chapa de acero alrededor de la banda y fijarla con al menos dos tornillos autorroscantes.
- 7- Anclar a pared las aletas perimetrales.
- 8- Fija la chapa de acero con tornillos de anclaje.

Ventilación



Ref. 3100 | Pág. 88
15 x 15



Ref. 3100 | Pág. 88
16 x 16 empotrar



Ref. 3100 | Pág. 88
17 x 17



Ref. 3100 | Pág. 89
20 x 20



Ref. 3100 | Pág. 89
20 x 20 empotrar



Ref. 3100 | Pág. 89
30 x 15



Ref. 3100 | Pág. 89
30 x 30



Ref. 3111 | Pág. 90
15 x 15



Ref. 3111 | Pág. 90
17 x 17



Ref. 3111 | Pág. 90
20 x 20



Ref. 3500AN | Pág. 91



Ref. 3500IN | Pág. 91



Ref. 3500JN | Pág. 91



Ref. 3500K | Pág. 91



Ref. 3500P | Pág. 91



Ref. 3500R | Pág. 92



Ref. 3500S | Pág. 92

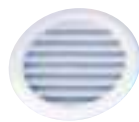

Ref. 3500N | Pág. 92



Ref. 3500MN | Pág. 92



Ref. 3203 | Pág. 93



Ref. 3207 | Pág. 93

REJILLAS DE ALUMINIO

ALUMINIUM GRILL



150 x 150
Paso de aire 120 cm²
Air passage 120 cm²

Disponible en Autoservicio p. 165.
Available in self-service p. 165.

Ref. 3100

Pincha QR para
ver ficha técnica.



150 x 150 mm

Referencia	D		€ u.
310015A	Aluminio	100	2,280
*310015M	Aluminio Madera	100	2,565
310015AB	Aluminio Blanca	100	2,508

* Hasta final de existencias / *Until end of stocks.*



160 x 160 Empotrar
Paso de aire 140 cm²
Air passage 140 cm²

Disponible en Autoservicio p. 165.
Available in self-service p. 165.

Pincha QR para
ver ficha técnica.



160 x 160 mm Empotrar

Referencia	D		€ u.
310016A	Aluminio	100	3,534
*310016M	Aluminio Madera	100	4,275
310016AB	Aluminio Blanca	100	4,218

* Hasta final de existencias / *Until end of stocks.*



170 x 170
Paso de aire 140 cm²
Air passage 140 cm²

Disponible en Autoservicio p. 165.
Available in self-service p. 165.

Pincha QR para
ver ficha técnica.



170 x 170 mm

Referencia	D		€ u.
310017A	Aluminio	100	2,622
*310017M	Aluminio Madera	100	3,477
310017AB	Aluminio Blanca	100	3,249

* Hasta final de existencias / *Until end of stocks.*

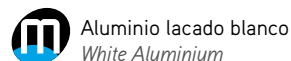

REJILLAS DE ALUMINIO

ALUMINIUM GRILL

Ref. 3100

Pincha QR para ver ficha técnica.



200 x 200
Paso de aire 160 cm²
Air passage 160 cm²

Disponible en Autoservicio p. 165.
Available in self-service p. 165.

200 x 200 mm			
Referencia	D		€ u.
310020A	Aluminio	100	3,135
310020AB	Aluminio Blanca	100	3,420

Pincha QR para ver ficha técnica.



200 x 200 Empotrar
Paso de aire 150 cm²
Air passage 150 cm²

200 x 200 mm Empotrar			
Referencia	D		€ u.
310020AE	Aluminio	80	4,617
310020ABE	Aluminio Blanca	80	6,327

Pincha QR para ver ficha técnica.



300 x 150
Paso de aire 160 cm²
Air passage 160 cm²

300 x 150 mm			
Referencia	D		€ u.
310030A	Aluminio	150	3,192
*310030M	Aluminio Madera	150	4,788

* Hasta final de existencias / *Until end of stocks.*

Pincha QR para ver ficha técnica.



300 X 300
Paso de aire 410 cm²
Air passage 410 cm²

300 x 300 mm			
Referencia	D		€ u.
31003030A	Aluminio	25	20,919
31003030AB	Aluminio Blanca	25	21,653



REJILLAS DE ALUMINIO CON MOSQUITERA

ALUMINIUM GRILL WITH MESH

Pincha QR para ver ficha técnica.



Ref. 3111

150 x 150 mm



150 x 150



Referencia	D		€ u.
311115A	Aluminio	25	3,999
311115AB	Aluminio Blanca	25	4,218

Disponible en Autoservicio p. 165.

Available in self-service p. 165.

Pincha QR para ver ficha técnica.



170 x 170



Referencia	D		€ u.
311117A	Aluminio	25	4,500
311117AB	Aluminio Blanca	25	5,220

Disponible en Autoservicio p. 165.

Available in self-service p. 165.

Pincha QR para ver ficha técnica.



200 x 200



Referencia	D		€ u.
311120A	Aluminio	25	5,100
311120AB	Aluminio Blanca	25	5,400

Disponible en Autoservicio p. 165.

Available in self-service p. 165.



Detalle de la mosquitera de la parte trasera.
Detail of the screen at the back.



REJILLAS DE PLÁSTICO

PLASTIC GRILLS

Ref. 3500



Pincha QR para ver ficha técnica.



AN

Referencia	T	D	M. interior (mm)	M. exterior (mm)		€ u.
3500AN	AN	Vertical c/marco (shunt)	95 x 220	130 x 260	60	4,266

Paso de aire 105 cm²
Air passage 105 cm²

Se le puede acoplar la mosquitera vertical ref. 3500JN.
Podemos fabricar con su marca. Consulte condiciones.

Disponible en Autoservicio p. 164.
Available in self-service p. 164.



Pincha QR para ver ficha técnica.



IN

Referencia	T	D	M. interior (mm)	M. exterior (mm)		€ u.
3500IN	IN	Vertical c/marco y cierre	105 x 235	130 x 260	60	5,279

Paso de aire 69 cm²
Air passage 69 cm²

Se le puede acoplar la mosquitera vertical ref. 3500JN.

Disponible en Autoservicio p. 164.
Available in self-service p. 164.



Pincha QR para ver ficha técnica.



JN

Referencia	T	D	M. exterior (mm)		€ u.
3500JN	JN	Mosquitera vertical	90 x 215	200	1,364

Paso de aire 45 cm²
Air passage 45 cm²

Para acoplar en las rejillas verticales ref. 3500AN y 3500IN.

Disponible en Autoservicio p. 164.
Available in self-service p. 164.



Pincha QR para ver ficha técnica.

Ref. 3500 (con red)



K

Referencia	T	D	M. interior (mm)	M. exterior (mm)		€ u.
3500K	K	150 x 200	115 x 165	150 x 200	50	3,298



Pincha QR para ver ficha técnica.



P

Referencia	T	D	M. interior (mm)	M. exterior (mm)		€ u.
3500P	P	230 x 230 lisa	210 x 200	230 x 230	60	5,262

REJILLAS DE PLÁSTICO CON RED

PLASTIC GRILLS WITH MESH

Ref. 3500 (con red)



R

Pincha QR para ver ficha técnica.



Referencia	T	D	M. interior (mm)	M. exterior (mm)		€ u.
3500R	R	Multi desde Ø125 a Ø170 mm	Ø170	Ø185	50	3,889



S

Pincha QR para ver ficha técnica.



Referencia	T	D	M. interior (mm)	M. exterior (mm)		€ u.
3500S	S	Multi desde Ø140 a Ø200 mm	Ø200	Ø220	40	5,967



N

Pincha QR para ver ficha técnica.



Referencia	T	D	M. interior (mm)	M. exterior (mm)		€ u.
3500N	N	Redonda Ø120 mm	Ø120	Ø150	70	2,040



MN

Pincha QR para ver ficha técnica.



Referencia	T	D	M. interior (mm)	M. exterior (mm)		€ u.
3500MN	MN	Multi desde Ø90 a Ø125 mm	Ø125	Ø130	100	2,792



Poliestireno
Polystyrene

Disponible en Autoservicio p. 164.
Available in self-service p. 164.

REJILLAS METÁLICAS AMT-AN

METALLIC STAMPED GRILL AMT-AN

Ref. 3203

Pincha QR para ver ficha técnica.

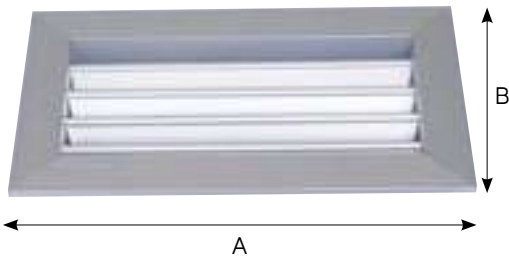

Referencia	A x B exterior (mm)	A x B interior (mm)	Color	€ u.
32032015	233 x 183	200 x 150	Aluminio gris	38,462
32033015	333 x 183	300 x 150	Aluminio gris	46,001
32033020	333 x 233	300 x 200	Aluminio gris	57,024
32034020	433 x 233	400 x 200	Aluminio gris	67,676

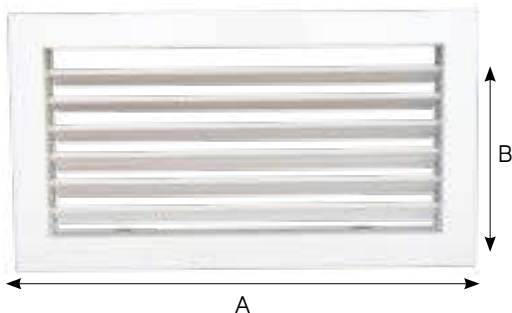

Ref. 3207

Referencia	A x B exterior (mm)	A x B interior (mm)	Color	€ u.
32072015	233 x 183	200 x 150	Aluminio blanco	38,833
32073015	333 x 183	300 x 150	Aluminio blanco	45,556
32073020	333 x 233	300 x 200	Aluminio blanco	57,584
32074020	433 x 233	400 x 200	Aluminio blanco	67,676

Deflectores y tubo flexible



Ref. 4153 | Pág. 95



Ref. 4153 | Pág. 95

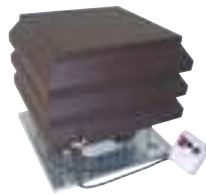

Ref. 4152 | Pág. 95



Ref. 4165 | Pág. 96



Ref. 4165 | Pág. 96

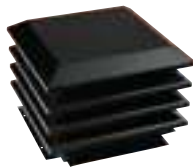

Ref. 4149 | Pág. 96



Ref. 4103 | Pág. 97



Ref. 5704D3 | Pág. 97



Ref. 4105 | Pág. 97



Ref. 4102 | Pág. 97



Ref. 5704M | Pág. 98



Ref. 5100 | Pág. 98

DEFLECTOR EÓLICO REDONDO

ROUND WIND REFLECTOR



La boca del deflector es hembra.
Female connection in baffle.



Acero galvanizado
Galvanized steel

Ref. 4153

Pincha QR para ver ficha técnica.



Referencia	Ø (mm)		€ u.
4153100	100	1	47,491
4153110	110	1	47,948
4153120	120	1	49,836
4153125	125	1	51,009
4153130	130	1	52,182
4153150	150	1	50,829
4153160	160	1	68,891
4153175	175	1	70,357
4153180	180	1	71,090
4153200	200	1	54,144
4153220	220	1	74,022
4153250	250	1	63,874
4153270	270	1	84,282
4153300	300	1	71,339
4153320	320	1	91,611
4153350	350	1	99,684
4153400	400	1	131,082
4153500	500	1	579,905

DEFLECTOR EÓLICO CUADRADO

SQUARE WIND REFLECTOR



La boca del deflector es hembra.
Female connection in baffle.



Acero galvanizado
Galvanized steel

Ref. 4153

Pincha QR para ver ficha técnica.



Referencia	M (mm)		€ u.
41531717	170 x 170	1	102,279
41532222	220 x 220	1	102,264
41532727	270 x 270	1	107,775
41533232	320 x 320	1	115,998
41533737	370 x 370	1	121,419
41534242	420 x 420	1	126,933
41534747	470 x 470	1	133,320
41535252	520 x 520	1	147,039

Los deflectores Eólicos y Brisa están fabricados para soportar vientos de hasta 60/70 km/h. Esta resistencia es inversamente proporcional al diámetro. En estufas o chimeneas se colocarán como mínimo a 6m. de distancia de la fuente de calor. Si alcanza temperaturas de 150º el lubricante se deteriora, se hace una masa y deja de girar. Se recomienda un mantenimiento cada 2 años.

Wind and Brise Deflector are made to bear wind speed until 60/70 km/h. They should be installed at a minimum distance of 6 m. from heat source in heaters or chimneys. Maintenance is advised every two years.

EXTRACTOR ELÉCTRICO TIRO FORZADO

ELECTRICAL SUCTIONER



Aspirador eléctrico para chimeneas, barbacoas y paelleros de leña.

6 velocidades



Acero pintado
Painted steel

Ref. 4152

Pincha QR para ver ficha técnica.



Referencia	Ø int. (mm)		€ u.
41524343	430 x 430	1	1.080,540

Especialmente indicado para barbacoas, chimeneas y paelleros de leña situados en espacios cerrados que necesiten tiro adicional. Regulador con 6 velocidades de aspiración.

DEFLECTOR BRISA REDONDO ACERO INOXIDABLE AISI 304

ROUND BRISA DEFLECTOR



Ref. 4165

Pincha QR para ver ficha técnica.



La boca del deflector es hembra.
Female connection in baffle.



Acero inoxidable (chapa exterior)
Stainless steel outside



Acero galvanizado (mecanismo interior)
Galvanized steel inside

Referencia	Ø (mm)		€ u.
4165100	100	1	96,736
4165110	110	1	97,666
4165120	120	1	100,854
4165125	125	1	103,756
4165130	130	1	105,534
4165150	150	1	102,797
4165160	160	1	146,991
4165175	175	1	152,518
4165180	180	1	154,070
4165200	200	1	110,515
4165220	220	1	160,280
4165250	250	1	118,850
4165270	270	1	174,812
4165300	300	1	137,425
4165320	320	1	198,410
4165350	350	1	210,084
4165400	400	1	280,883

DEFLECTOR BRISA CUADRADO ACERO INOXIDABLE AISI 304

SQUARE BRISA DEFLECTOR



Ref. 4165

Pincha QR para ver ficha técnica.



La boca del deflector es hembra.
Female connection in baffle.



Acero inoxidable (chapa exterior)
Stainless steel outside



Acero galvanizado (mecanismo interior)
Galvanized steel inside

Referencia	M (mm)		€ u.
41651717	170 x 170	1	186,260
41652222	220 x 220	1	186,260
41652727	270 x 270	1	198,142
41653232	320 x 320	1	218,263
41653737	370 x 370	1	237,435
41654242	420 x 420	1	252,963
41654747	470 x 470	1	273,958
41655252	520 x 520	1	287,663

Bajo pedido se pueden suministrar otras medidas y acabados en cobre. Consultar.
We can manufacture different measures and copper finish upon request. Please ask.

Los deflectores Eólicos y Brisa están fabricados para soportar vientos de hasta 60/70 km/h. Esta resistencia es inversamente proporcional al diámetro. En estufas o chimeneas se colocarán como mínimo a 6m. de distancia de la fuente de calor. Si alcanza temperaturas de 150º el lubricante se deteriora, se hace una masa y deja de girar. Se recomienda un mantenimiento cada 2 años.

Wind and Brise Deflector are made to bear wind speed until 60/70 km/h. They should be installed at a minimum distance of 6 m. from heat source in heaters or chimneys. Maintenance is advised every two years.

DEFLECTOR STRATOS

STRATOS DEFLECTOR



Ref. 4149

Pincha QR para ver ficha técnica.



Acero pintado negro
Black painted steel

Referencia	Int. (mm)	Ext. (mm)		€ u.
41492020	200 x 200	340 x 340	1	365,783
41492525	250 x 250	390 x 390	1	384,494
41493030	300 x 300	440 x 440	1	403,253
41494040	400 x 400	540 x 540	1	443,641
41495050	500 x 500	640 x 640	1	586,158
41496060	600 x 600	740 x 740	1	826,686

DEFLECTOR 3 DISCOS CHAPA ACERO BLANCO PARA TUBO DE ALUMINIO FLEXIBLE

3 DISC VENTILATION BAFFLE



Acero con pintura epoxi blanca
White epoxy painted steel

Ref. 4103

Pincha QR para ver ficha técnica.



Referencia	Ø (mm)		€ u.
4103100	100	1	7,466
4103110	110	1	7,515
4103120	120	1	7,638
4103125	125	1	7,696
4103130	130	1	8,333
4103150	150	1	16,604

La boca del deflector es macho.
Male connection in baffle.

DEFLECTOR 3 DISCOS ALUMINIO BLANCO PARA TUBO DE ALUMINIO FLEXIBLE

WHITE ALUMINIUM 3 DISC VENTILATION BAFFLE



Aluminio con pintura epoxi blanca
White epoxy painted aluminium

Ref. 5704D3

Pincha QR para ver ficha técnica.



Referencia	Ø (mm)		€ u.
5704D3100	100	1	16,120
5704D3110	110	1	16,199
5704D3120	120	1	16,483
5704D3125	125	1	16,687

La boca del deflector es macho. Adecuado para zonas costeras.
Male connection in baffle. Suitable for seaside areas.

DEFLECTOR ACERO INOXIDABLE "N" PARA TUBO DE ALUMINIO FLEXIBLE

STAINLESS STEEL "N" TYPE BAFFLE



Acero inoxidable Aisi 304
Stainless steel Aisi 304

Ref. 4105

Pincha QR para ver ficha técnica.



Referencia	Ø (mm)		€ u.
4105100	100	1	40,258
4105110	110	1	43,564
4105120	120	1	45,421
4105125	125	1	48,592
4105130	130	1	61,500

La boca del deflector es macho. Adecuado para zonas costeras.
Male connection in baffle. Suitable for seaside areas.

DEFLECTOR 3 DISCOS CHAPA ACERO BLANCO PARA TUBO DE ALUMINIO RÍGIDO

WHITE STEEL 3 DISC VENTILATION BAFFLE



Acero con pintura epoxi blanca
White epoxy painted steel

Ref. 4102

Pincha QR para ver ficha técnica.



Referencia	Ø (mm)		€ u.
4102100	100	1	7,466
4102110	110	1	7,515
*4102120	120	1	7,638
4102125	125	1	7,696
*4102130	130	1	5,500

* Hasta final de existencias / Until end of stocks.

La boca del deflector es hembra.
Female connection in baffle.

DEFLECTOR 3 DISCOS DE ALUMINIO BLANCO PARA TUBO DE ALUMINIO RÍGIDO

WHITE STEEL 3 DISC ALUMINIUM BAFFLE



Ref. 5704M

Pincha QR para ver ficha técnica.



Referencia	Ø (mm)		€ u.
5704M100	100	1	14,630
5704M110	110	1	14,763
5704M125	125	1	14,869



Aluminio con pintura epoxi blanca
White epoxi painted aluminium

La boca del deflector es hembra.
Adecuado para zonas costeras.
Female connection in baffle.
Suitable for seaside areas.

TUBO FLEXIBLE ALUMINIO

FLEXIBLE ALUMINIUM TUBE



Ref. 5100

Pincha QR para ver ficha técnica.



Referencia	Ø int. (mm)			€ m.
5100080	80	125	8	3,900
5100090	90	125	8	3,960
5100100	100	100	8	3,740
5100110	110	80	8	3,905
5100120	120	80	8	4,290
5100125	125	70	8	5,100
5100130	130	60	8	5,340
5100140	140	60	8	6,080
5100150	150	45	8	6,363
5100160	160	45	8	7,150
5100180	180	30	8	8,515
5100200	200	20	8	9,176
5100250	250	20	8	11,748
5100300	300	10	8	15,246
5100350	350	5	8	22,610
5100400	400	5	8	23,030

= Metros por caja. 1 caja es el pedido mínimo.
= Meters per box. 1 box minimum order.

= Nº de cajas por palet.
= Number of boxes per pallet.



Aluminio
Aluminium

Canales de drenaje



Canal HS 100 | Pág. 100



Accesorios HS 100 | Pág. 100

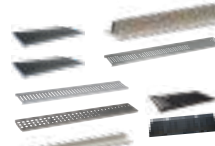

Rejas HS 100 | Pág. 101



Canal HS 150 | Pág. 102



Accesorios HS 150 | Pág. 102



Rejas HS 150 | Pág. 103



Canal HS 200 | Pág. 104



Rejas HS 200 | Pág. 104



Accesorios HS 200 | Pág. 104



Canal HX 100+Rejas D400 | Pág. 105



Canal HX 150+Rejas D400 | Pág. 105



Canal HX 200+Rejas D400 | Pág. 105



Canal HX 300+Rejas D400 | Pág. 106

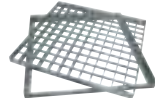

37300 (malla 33 x 33) | Pág. 106



37300 (malla 33 x 33) | Pág. 106



37100 (malla 30 x 10) | Pág. 106



Canal HSB 100/50 | Pág. 107



Rejas HSB 100/50 | Pág. 107



Accesorio HSB 100/50 | Pág. 107



Canal HSP 1 | Pág. 108



Canal HSP 2 | Pág. 109



Canal basic | Pág. 110



Módulos rejilla piscina | Pág. 111



Rejilla modular piscina | Pág. 111



Ecocanal 200 | Pág. 112



Rejas Ecocanal 200 | Pág. 112



Accesorios Ecocanal 200 | Pág. 112



Módulo canal 130 | Pág. 113



Reja 130 | Pág. 113



Accesorios 130 | Pág. 113



Módulo canal 200 | Pág. 114



Reja 200 | Pág. 114



Accesorios 200 | Pág. 114

CANAL HS MODELO 100

HS CHANNEL MODEL 100

Pincha QR para ver ficha técnica.

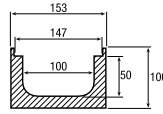

Longitud 1 metro.
Salida inferior Ø110.
1 m. long.
Bottom outlet Ø110.

Compatible con todas las rejas y kits de fijación (excepto 38600KIT11).
Compatible with all gratings and fastening kits (except 38600KIT11).

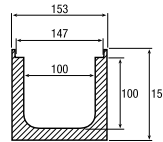

Longitud 1 metro.
Salida inferior Ø110.
Salida lateral Ø90
1 m. long.
Bottom outlet Ø110.
Lateral outlet Ø90.

Compatible con todas las rejas y kits de fijación.
Compatible with all gratings and fastening kits.

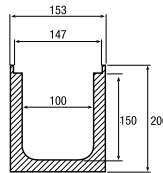

Longitud 1 metro.
Salida inferior Ø110.
Salida lateral Ø110
1 m. long.
Bottom outlet Ø110.
Lateral outlet Ø110.

Compatible con todas las rejas y kits de fijación.
Compatible with all gratings and fastening kits.

Kit con 3 m de canal HS 100/50 + Reja en Autoservicio p. 162-164.



Polipropileno
Polypropylene

Ref. 38600

Referencia	Denominación			€ u.
38600C100	Canal HS de 100 x 50 de 1 m de longitud	1	104	35,312
38600C101	Canal HS de 100 x 100 de 1 m de longitud	1	64	42,748
38600C102	Canal HS de 100 x 150 de 1 m de longitud	1	48	51,298

ACCESORIOS PARA CANAL HS MODELO 100

FASTENING DEVICES FOR HS CHANNEL MODEL 100

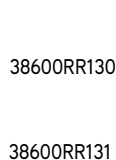
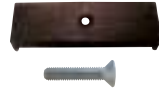

Ref. 38600

Referencia	Denominación	€ u.
38600TAP05	Tapa 100 x 50	3,995
38600TAP10	Tapa 100 x 100	5,398
38600TAP11	Tapa 100 x 150	8,875
38600KIT09	Bolsa de 2 clavijas plástico y 2 tornillos	5,291
38600KIT11	Bolsa de 2 clavijas metálicas y 2 tornillos	18,695
38600KIT12	Bolsa de 8 tuercas metálicas y 8 tornillos	14,697
38600FIX10	Bolsa de 2 clavijas plástico y 2 tornillos inox.	17,600
38600RR130	0,5m registro reja ranurada H2,5cm acero galvanizado	103,020
38600RR131	0,5m registro reja ranurada H10cm acero galvanizado	189,880

Las aplicaciones son meramente orientativas. El responsable de la obra decidirá la que necesite en función de las necesidades y del cumplimiento de la norma EN 1433.
Uses are merely indicative. The responsible for the building work is the one to decide depending on needs and in accordance to Norm EN 1433.

REJAS PARA CANAL HS MODELO 100

GRATINGS FOR HS CHANNEL MODEL 100

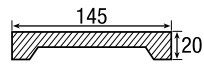
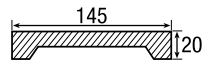
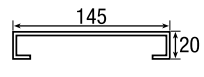
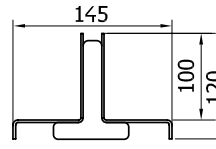
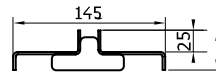
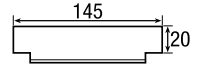
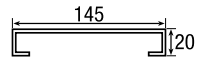
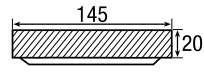
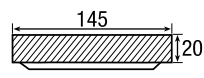
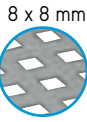
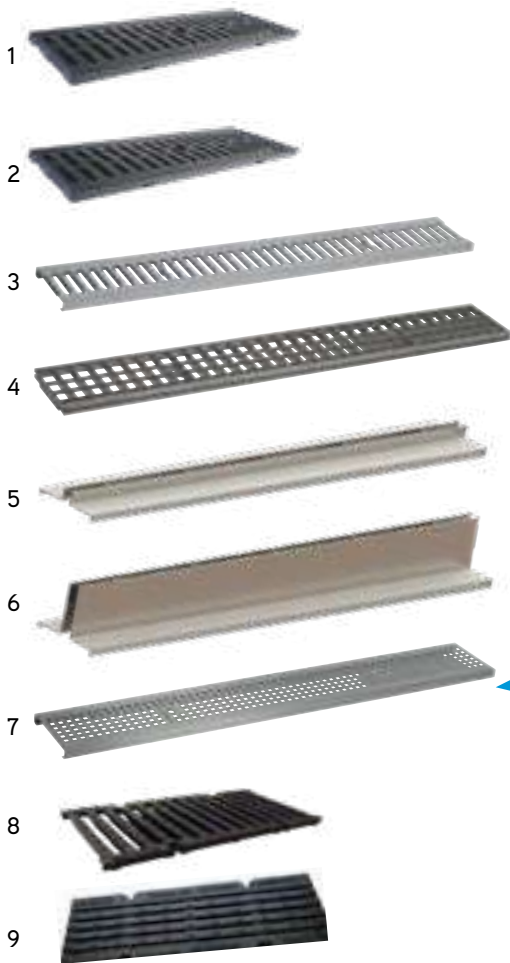

POLIPROPILENO

1. Pasarela plástico negra A15
Peso 0,58 / 1 Kg. Long. 0,5 m.
Ensamblaje rápido click-clack.

COMPOSITE (PA + FIBRA DE VIDRIO)

2. Pasarela plástico negra B125 / C250
Peso 1 Kg. Long. 0,5 m.

ACERO GALVANIZADO

3. Pasarela acero galvanizada A15
Peso 1,5 Kg. Long. 1 m.
4. Entramada 30x30 acero galvanizada B125
Peso 2,7 Kg. Long. 1 m.

5. Ranura central altura 2.5cm acero galva
Longitud 1 m. Ancho de ranura 2cm.

6. Ranura central altura 10cm acero galva
Longitud 1 m. Ancho de ranura 2cm.

ACERO INOXIDABLE

7. Piscina acero inoxidable Aisi 316
Peso 1,6 Kg. Long. 1 m.



FUNDICIÓN DÚCTIL

8. Fundición dúctil C250
Peso 4 kg. Long. 0,5 m.
9. Fundición dúctil antitacón C250
Peso 4 kg. Long. 0,5 m.

Ref. 38600

Referencia	Nº	Denominación	Long.	Aplicación	Resistencia Norma EN 1433			€ u.
38600R100	1	Reja plástico negra A15	0,50 m.	Superficies peatonales	Clase A15	1	240	9,347
38600R101	3	Reja Pasarela acero galvanizado A15	1 m.	Superficies peatonales	Clase A15	1	400	32,717
38600R104	2	Reja composite negra B125	0,50 m.	Zona aparcamiento de coches	Clase B125	1	240	45,299
38600R105	4	Reja Entramada 30x30 acero galvanizado B125	1 m.	Zona aparcamiento de coches	Clase B125	1	200	98,148
38600R108	2	Reja composite negra C250	0,50 m.	Tráfico ligero	Clase C250	1	240	55,686
38600R109	8	Reja Fundición dúctil C250	0,50 m.	Tráfico ligero	Clase C250	1	228	69,228
38600R109A	9	Reja antitacón Fundición dúctil C250	0,50 m.	Tráfico ligero	Clase C250	1	132	122,545
38600R120	7	Reja Piscina acero inox. Aisi 316 A15	1 m.	Superficies peatonales	Clase A15	1	64	260,000
38600R130	5	Reja Ranura central H2,5cm acero galvanizado	1 m.	Superficies peatonales	-	1	240	88,375
38600R131	6	Reja Ranura central H10cm acero galvanizado	1 m.	Superficies peatonales	-	1	120	140,390

CANAL HS MODELO 150

HS CHANNEL MODEL 150

Pincha QR para ver ficha técnica.

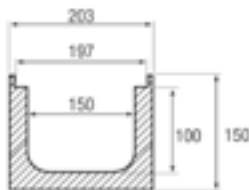

Longitud 1 metro.
Salida inferior Ø110.
Salida lateral Ø90
1 m. long.
Bottom outlet Ø110.
Lateral outlet Ø90.

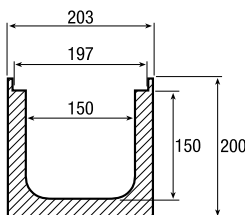

Longitud 1 metro.
Salida inferior Ø110.
Salida lateral Ø110
1 m. long.
Bottom outlet Ø110.
Lateral outlet Ø110.

Compatible con todas las rejas y kits de fijación.
Compatible with all gratings and fastening kits.

Ref. 38600



Polipropileno
Polypropylene

Referencia	Denominación			€ u.
38600C150	Canal HS de 150 x 100 de 1 metro de longitud	1	48	46,737
38600C151	Canal HS de 150 x 150 de 1 metro de longitud	1	36	55,573

ACCESORIOS PARA CANAL HS MODELO 150

FASTENING DEVICES FOR HS CHANNEL MODEL 150



Tapa 150 x 100



Tapa 150 x 150



38600KIT15
Para HS CON REJA
PASARELA Y
ENTRAMADA



38600KIT12
Para HS
CON REJA
FUNDICION.

Ref. 38600

Referencia	Denominación	€ u.
38600TAP15	Tapa 150 x 100	8,875
38600TAP16	Tapa 150 x 150	8,910
38600KIT15	Bolsa de 2 clavijas metálicas y 2 tornillos	20,772
38600KIT12	Bolsa con 8 tornillos y 8 tuercas	14,697

Las aplicaciones son meramente orientativas. El responsable de la obra decidirá la que necesite en función de las necesidades y del cumplimiento de la norma EN 1433.
Uses are merely indicative. The responsible for the building work is the one to decide depending on needs and in accordance to Norm EN 1433.

REJAS PARA CANAL HS MODELO 150

GRATINGS FOR HS CHANNEL MODEL 150

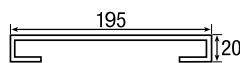

ACERO GALVANIZADO

1. Pasarela acero galvanizada A15
Peso 2,5 Kg. Long. 1 m.

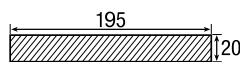

COMPOSITE (PA + FIBRA DE VIDRIO)

2. Pasarela plástico negra B125 / C250
Peso 0,58 / / 1 Kg. Long. 0,5 m.

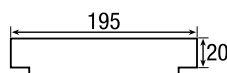

3. Entramada 30x30 acero galvanizada B125
Peso 2,7 Kg. Long. 1 m.

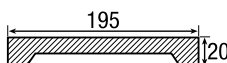

FUNDICIÓN DÚCTIL

4. Fundición dúctil C250
Peso 4 kg. Long. 0,5 m.

Ref. 38600

Referencia	Nº	Denominación	Long.	Aplicación	Resistencia Norma EN 1433			€ u.
38600R151	1	Reja Pasarela acero galvanizado A15	1 m.	Superficies peatonales	Clase A15	1	300	67,394
38600R154	2	Reja composite negra B125	0,5 m.	Zona aparcamiento de coches	Clase B125	1	180	59,115
38600R155	3	Reja Entramada 30x30 acero galvanizado B125	1 m.	Zona aparcamiento de coches	Carga B125	1	200	128,414
38600R159	4	Reja Fundición dúctil C250	0,5 m.	Tráfico ligero	Clase C250	1	176	97,448

CANAL HS MODELO 200

HS CHANNEL MODEL 200

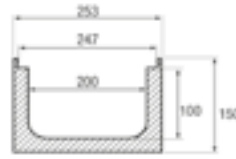
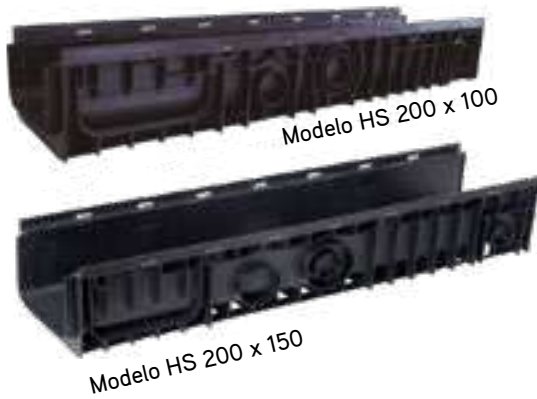

Pincha QR para ver ficha técnica.

Longitud 1 metro.
Salida inferior Ø110-160.
Salida lateral Ø90
1 m. long.
Bottom outlet Ø110-160.
Lateral outlet Ø90.

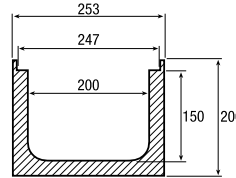

Longitud 1 metro.
Salida inferior Ø110-160.
Salida lateral Ø90-110
1 m. long.
Bottom outlet Ø110-160.
Lateral outlet Ø90-110.

Ref. 38600

Referencia	Denominación			€ u.
38600C200	Canal HS de 200 x 100 de 1 metro de longitud	1	40	62,316
38600C201	Canal HS de 200 x 150 de 1 metro de longitud	1	30	75,502

REJAS PARA CANAL HS MODELO 200

GRATINGS FOR HS CHANNEL MODEL 200

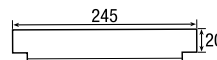

REJAS

ACERO GALVANIZADO

1. Entramada 30x30 acero galvanizado B125
Peso 6 Kg. Long. 1 m.

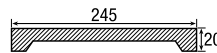

FUNDICIÓN DÚCTIL

2. Fundición dúctil C250
Peso 6,5 kg. Long. 0,5 m.

Ref. 38600

Referencia	Nº	Denominación	Long.	Aplicación	Resistencia Norma EN 1433			€ u.
38600R205	1	Reja Entramada 30x30 acero galvanizado B125	1 m.	Zona aparcamiento de coches	Clase B125	1	100	197,410
38600R209	2	Reja Fundición dúctil C250	0,5 m.	Tráfico ligero	Clase C250	1	108	134,922

ACCESORIOS PARA CANAL HS MODELO 200

FASTENING DEVICES FOR HS CHANNEL MODEL 200

38600KIT20

38600KIT12

Tapa 200 x 100

Tapa 200 x 150



Para HS CON REJA FUNDICION.

Ref. 38600

Referencia	Denominación	€ u.
38600TAP20	Tapa 200 x 100	14,035
38600TAP21	Tapa 200 x 150	14,462
38600KIT20	Bolsa de 2 clavijas metálicas y 2 tornillos	22,849
38600KIT12	Bolsa con 8 tornillos y 8 tuercas	14,697

Las aplicaciones son meramente orientativas. El responsable de la obra decidirá la que necesite en función de las necesidades y del cumplimiento de la norma EN 1433.
Uses are merely indicative. The responsible for the building work is the one to decide depending on needs and in accordance to Norm EN 1433.

CANAL HX MODELO 100 CON BASTIDOR METÁLICO + REJAS D400

HX CHANNEL MODEL 100 + GRATING D400



Pincha QR para ver ficha técnica.

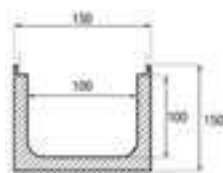

CANAL
 Longitud 1 metro.
 Salida inferior Ø110.
 Salida lateral Ø90.
 1 m. long.
 Bottom outlet Ø110.
 Lateral outlet Ø90.

REJAS
 Fundición dúctil D400.
 Peso 5 kg x 2. Longitud 0,5 m x 2.

Ref. 38610

Referencia	Denominación	Long.	Aplicación	Resistencia Norma EN 1433			€ u.
38610D101	Canal HX modelo 100 x 100 + rejas de fundición dúctil D400, montadas sobre bastidor con tornillos	1 m.	Tráfico pesado	D400	1	54	359,379

CANAL HX MODELO 150 CON BASTIDOR METÁLICO + REJAS D400

HX CHANNEL MODEL 150 + GRATING D400

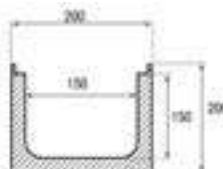
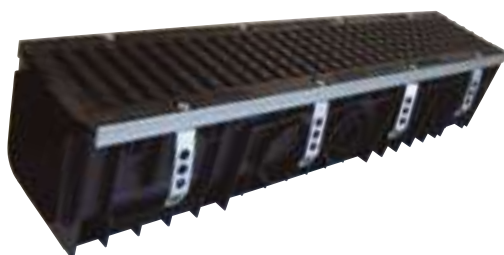

CANAL
 Longitud 1 metro.
 Salida inferior Ø110.
 Salida lateral Ø110.
 1 m. long.
 Bottom outlet Ø110.
 Lateral outlet Ø110.

REJAS
 Fundición dúctil D400.
 Peso 6,9 kg x 2. Longitud 0,5 m x 2.

Ref. 38610

Referencia	Denominación	Long.	Aplicación	Resistencia Norma EN 1433			€ u.
38610D151	Canal HX modelo 150 x 150 + rejas de fundición dúctil D400, montadas sobre bastidor con tornillos	1 m.	Tráfico pesado	D400	1	36	466,868

CANAL HX MODELO 200 CON BASTIDOR METÁLICO + REJAS D400

HX CHANNEL MODEL 200 + GRATING D400

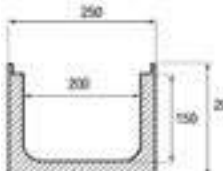

CANAL
 Longitud 1 metro.
 Salida inferior Ø110-160.
 Salida lateral Ø110.
 1 m. long.
 Bottom outlet Ø110-160.
 Lateral outlet Ø110.

REJAS
 Fundición dúctil D400.
 Peso 9,2 kg x 2. Longitud 0,5 m x 2.

Ref. 38610

Referencia	Denominación	Long.	Aplicación	Resistencia Norma EN 1433			€ u.
38610D201	Canal HX modelo 200 x 150 + rejas de fundición dúctil D400, montadas sobre bastidor con tornillos	1 m.	Tráfico pesado	D400	1	30	605,269

Las tapas de inicio y final son comunes con la serie HS.

CANAL HX MODELO 300 CON BASTIDOR METÁLICO + REJAS D400

HX CHANNEL MODEL 300 + GRATING D400

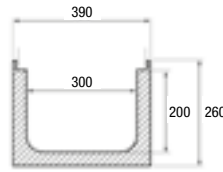

CANAL
 Longitud 0,5 metro.
 Salida inferior Ø160.
 Salida lateral Ø200.
 0.5 m. long.
 Bottom outlet Ø160.
 Lateral outlet Ø200.

REJAS
 Fundición dúctil D400.
 Peso 18,8 kg. Longitud 0,5 m

Ref. 38610

Referencia	Denominación	Long.	Aplicación	Resistencia Norma EN 1433		€ u.
38610D301	Canal HX modelo 300 x 200 + reja de fundición dúctil D400, montada sobre bastidor con tornillos	0,5 m.	Tráfico pesado	D400	1	579,368

ACCESORIOS PARA CANAL HX MODELO 300

FASTENING DEVICES FOR HX CHANNEL MODEL 300



Referencia	Denominación	€ u.
38610TAP30	Tapa 300 x 200	86,479

REJILLAS ENTRAMADAS DE 33 X 33 CON MARCO GALVANIZADAS PEATONALES

GALVANIZED SLOTTED STEEL GRATINGS 33x33 WITH FRAME

Pincha QR para ver ficha técnica.



33 x 33

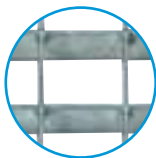

Acero galvanizado
Galvanized steel

Ref. 37300 (malla de 33 x 33)

Referencia	M (mm)		€ u.
3730010116	1010 x 160 x 30	10	103,678
3730010121	1010 x 210 x 30	10	124,812
3730010126	1010 x 260 x 30	10	143,900
3730010131	1010 x 310 x 30	10	165,033
373003131	310 x 310 x 30 cuadrada	10	57,151
373004141	410 x 410 x 30 cuadrada	10	90,953
373005151	510 x 510 x 30 cuadrada	10	133,276

REJILLAS ENTRAMADAS DE 30 X 10 CON MARCO GALVANIZADAS PEATONALES

GALVANIZED SLOTTED STEEL GRATINGS 30x10 WITH FRAME

Pincha QR para ver ficha técnica.



30 x 10

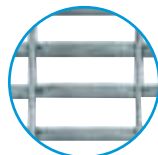

Acero galvanizado
Galvanized steel

Ref. 37100 (malla de 30 x 10 antitacón)

Referencia	M (mm)		€ u.
3710010015	1000 x 150 x 30	10	135,378
3710010020	1000 x 200 x 30	10	167,135
3710010030	1000 x 300 x 30	10	224,229

CANAL HSB MODELO 100

HSB CHANNEL MODEL 100

Pincha QR para ver ficha técnica.

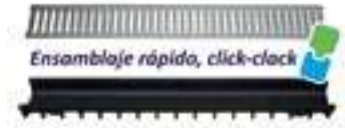

Kit con 3 m de canal HS 100/50 + Reja en Autoservicio p. 161.

Altura 67/117 mm.
Sin tornillos.
Sin clavijas.
Fácil instalación.
Marcado **CE**
Ensamblaje rápido, click-clack.

Size, 67/117 mm.
Without screws.
Without brackets.
Easy installation.
CE Marked
Fast assembly, click-clack.

CANAL HSB MODELO 100

HS CHANNEL HSB MODEL 100

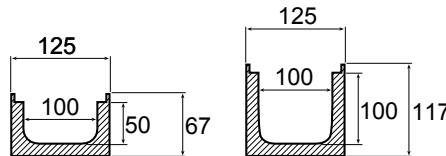

Longitud 1 metro.
Salida inferior Ø75/90.
1 m. long.
Bottom outlet Ø75/90.

Ref. 38607

Referencia	Denominación			€ u.
38607C100	Canal HSB de 100 x 50 de 1 metro de longitud	1	136	19,597
38607C101	Canal HSB de 100 x 100 de 1 metro de longitud	1	80	23,516

REJA PARA CANAL HSB MODELO 100

GRATINGS FOR HSB CHANNEL MODEL 100

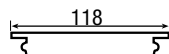

ACERO GALVANIZADO
1. Pasarela acero galvanizada A15
Peso 1,2 Kg. Long. 1 m.

Marcado **CE**

Ref. 38607

Referencia	Nº	Denominación	Long.	Aplicación	Resistencia Norma EN 1433			€ u.
38607R101	1	Reja Pasarela acero galvanizado A15	1 m.	Superficies peatonales	Clase A15	1	480	20,576

ACCESORIOS PARA CANAL HSB MODELO 100

FASTENING DEVICES FOR HSB CHANNEL MODEL 100



Ref. 38607

Referencia	Denominación	€ u.
38607TAP05	Tapa HSB 100 x 50	3,152
38607TAP10	Tapa HSB 100 x 100	4,260

Las aplicaciones son meramente orientativas. El responsable de la obra decidirá la que necesite en función de las necesidades y del cumplimiento de la norma EN 1433.
Uses are merely indicative. The responsible for the building work is the one to decide depending on needs and in accordance to Norm EN 1433.

CANAL HSP 1

HSP 1 CHANNEL

Pincha QR para ver ficha técnica.

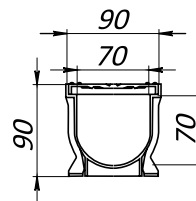

REJAS

POLIPROPILENO

1. Pasarela en negro Long. 0,5 m.
2. Pasarela en gris. Long. 0,5 m.

ACERO GALVANIZADO

3. Pasarela acero galvanizada . Long. 1 m.

CANAL

POLIPROPILENO

Longitud 1 metro.
Salida inferior Ø75-110.
Salida lateral Ø50

Ref. 38401

Referencia	Denominación	Long.	Aplicación	Resistencia Norma EN 1433			€ u.
38401CRN	Canal HSP 1 + 2 uds Reja de Plástico Negro	1 m.	Superficies peatonales	Clase A15	1	273	20,737
38401CRG	Canal HSP 1 + 2 uds Reja de Plástico Gris	1 m.	Superficies peatonales	Clase A15	1	273	26,619
38401CRP	Canal HSP 1 + Reja Galvanizada	1 m.	Superficies peatonales	Clase A15	1	300	20,737

ACCESORIOS PARA CANAL HSP 1

DEVICES FOR HSP 1 CHANNEL



Ref. 38401

Referencia	Denominación	€ u.
38401B01	Boquilla canal HSP1 salida Ø75-110	4,463
38401T01	Tapa canal HSP1 salida Ø50	2,888
38400A25	Arqueta HSP 25x25 con rejilla y cestillo de plástico clase A15	37,820

Las aplicaciones son meramente orientativas. El responsable de la obra decidirá la que necesite en función de las necesidades y del cumplimiento de la norma EN 1433.
Uses are merely indicative. The responsible for the building work is the one to decide depending on needs and in accordance to Norm EN 1433.

CANAL HSP 2

HSP 2 CHANNEL



Pincha QR para ver ficha técnica.

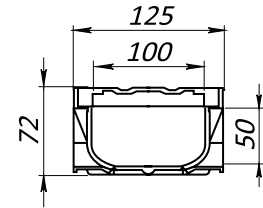

REJAS

POLIPROPILENO

1. Pasarela en negro Long. 1 m.
2. Pasarela en gris Long. 1 m.
3. Pasarela en blanco Long. 1 m.

ACERO GALVANIZADO

4. Pasarela acero galvanizada Long. 1 m.

CANAL

POLIPROPILENO

Longitud 1 metro.
Salida inferior Ø110 con accesorio ref. 38402B02.

Ref. 38402

Referencia	Denominación	Long.	Aplicación	Resistencia Norma EN 1433			€ u.
38402CRN	Canal HSP 2 + Reja de Plástico Negro	1 m.	Superficies peatonales	Clase A15	1	270	20,970
38402CRG	Canal HSP 2 + Reja de Plástico Gris	1 m.	Superficies peatonales	Clase A15	1	270	26,250
38402CRB	Canal HSP 2 + Reja de Plástico Blanco	1 m.	Superficies peatonales	Clase A15	1	270	40,425
38402CRP	Canal HSP 2 + Reja de Galvanizada	1 m.	Superficies peatonales	Clase A15	1	270	35,700

ACCESORIOS PARA CANAL HSP 2

DEVICES FOR HSP 2 CHANNEL

38400A25

Ref. 38402



Referencia	Denominación	€ u.
38402B02	Boquilla canal HSP2 salida Ø110	5,513
38402T02	Tapa canal HSP2	3,938
38402AA02	Adaptador arqueta HSP2	6,710
38400A25	Arqueta HSP 25x25 con rejilla y cestillo de plástico clase A15	37,820

ACCESORIOS PARA CANAL BASIC

DEVICES FOR BASIC CHANNEL



38410T01

38410T02

Ref. 38410

Referencia	Denominación	€ u.
38410T01	Tapa canal basic 100x46/56	3,036
38410T02	Tapa canal basic 100x85	5,510

Las aplicaciones son meramente orientativas. El responsable de la obra decidirá la que necesite en función de las necesidades y del cumplimiento de la norma EN 1433.
Uses are merely indicative. The responsible for the building work is the one to decide depending on needs and in accordance to Norm EN 1433.

CANAL BASIC

BASIC CHANNEL



Canal basic 100 x 46

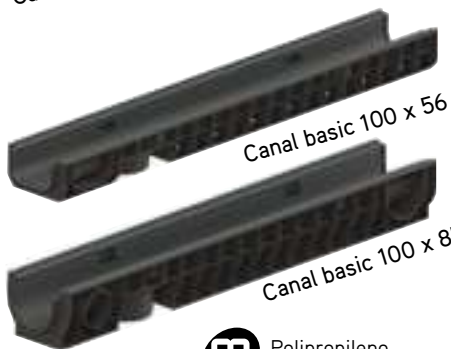

Canal basic 100 x 56

Canal basic 100 x 85



Polipropileno
Polypropylene

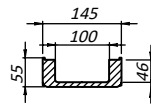

Longitud 1 metro.
Salida inferior Ø110.
1 m. long.
Bottom outlet Ø110.

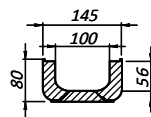

Longitud 1 metro.
Salida inferior Ø110.
1 m. long.
Bottom outlet Ø110.
Lateral outlet Ø90.

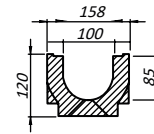

Pincha QR para ver ficha técnica.

Longitud 1 metro.
Salida inferior Ø110.
Salida lateral Ø90
1 m. long.
Bottom outlet Ø110.
Lateral outlet Ø90.

Ref. 38410

Referencia	Denominación			€ u.
38410C100	Canal Basic 100 x 46 de 1 m de longitud	1	480	14,477
38410C101	Canal Basic 100 x 56 de 1 m de longitud	1	336	17,746
38410C102	Canal Basic 100 x 85 de 1 m de longitud	1	182	22,883

REJAS RANURADA PARA CANAL BASIC

SLOTTED GRATINGS FOR BASIC CHANNEL

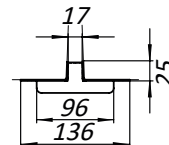
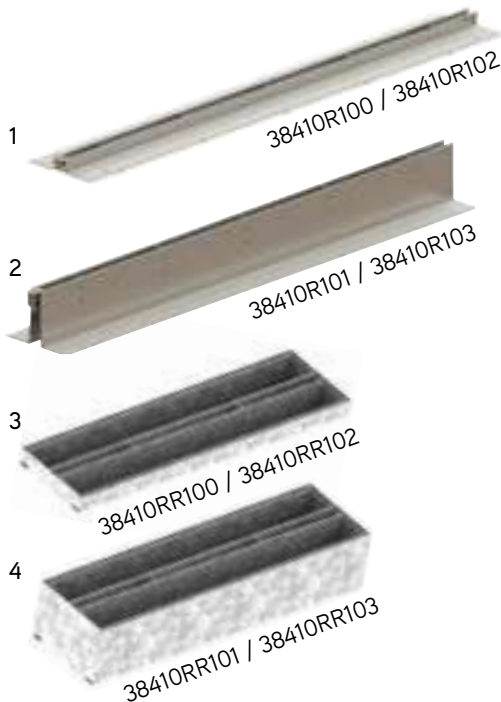

ACERO GALVANIZADO

- Reja ranura central 100-25 mm acero galvanizado
Long. 1 m. Área de evacuación 170cm²
- Reja ranura central 100-100 mm acero galvanizado
Long. 1 m. Área de evacuación 170cm²
- Registro reja ranura central 100-25 mm acero galvanizado
Long. 0,5 m. Área de evacuación 85cm²
- Registro reja ranura central 100-100 mm acero galvanizado
Long. 0,5 m. Área de evacuación 85cm²

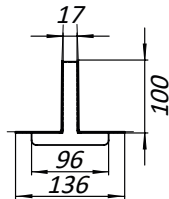

ACERO INOXIDABLE

- Reja ranura central 100-25 mm acero inoxidable
Long. 1 m. Área de evacuación 170cm²
- Reja ranura central 100-100 mm acero inoxidable
Long. 1 m. Área de evacuación 170cm²
- Registro reja ranura central 100-25 mm acero inoxidable
Long. 0,5 m. Área de evacuación 85cm²
- Registro reja ranura central 100-100 mm acero inoxidable
Long. 0,5 m. Área de evacuación 85cm²

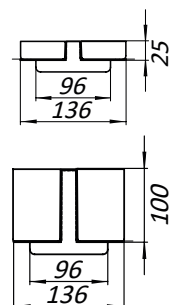

Ref. 38410

Referencia	Nº	Denominación	Longitud			€ u.
38410R100	1	Reja ranura central 100-25 mm Acero galvanizado	1 m.	1	300	81,725
38410R102	1	Reja ranura central 100-25 mm Acero inoxidable	1 m.	1	300	179,950
38410R101	2	Reja ranura central 100-100 mm Acero galvanizado	1 m.	1	160	129,826
38410R103	2	Reja ranura central 100-100 mm Acero inoxidable	1 m.	1	160	486,780
38410RR100	3	Registro reja ranura central 100-25 mm Acero galvanizado	0,50 m.	1	300	95,268
38410RR102	3	Registro reja ranura central 100-25 mm Acero inoxidable	0,50 m.	1	300	238,510
38410RR101	4	Registro reja ranura central 100-100 mm Acero galvanizado	0,50 m.	1	100	175,592
38410RR103	4	Registro reja ranura central 100-100 mm Acero inoxidable	0,50 m.	1	100	486,780

Las aplicaciones son meramente orientativas. El responsable de la obra decidirá la que necesite en función de las necesidades y del cumplimiento de la norma EN 1433.
Uses are merely indicative. The responsible for the building work is the one to decide depending on needs and in accordance to Norm EN 1433.

REJILLA MODULAR PISCINA

MODULAR POOL GRILL

Pincha QR para ver ficha técnica.



Polipropileno
Polypropylene

Ref. 36350

Referencia	Denominación	M (mm)	u.	Metros	€ u.
363502022E	Módulo estrecho	195 x 22	500	11,11	1,283
363502522E	Módulo estrecho	245 x 22	375	8,33	1,339
36350E022E	Esquina estrecha	195 x 22	1	-	116,812
36350E522E	Esquina estrecha	245 x 22	1	-	113,175



Referencia	Denominación	M (mm)	u.	Metros	€ u.
3635020350	Módulo ondulado	195 x 35	540	10,19	1,283
3635025350	Módulo ondulado	245 x 35	400	7,55	1,339
36350E0350	Esquina ondulada	195 x 35	1	-	106,674
36350E5350	Esquina ondulada	245 x 35	1	-	117,639



Referencia	Denominación	M (mm)	u.	Metros	€ u.
363502035R	Módulo recto	195 x 35	470	10,44	1,228
363502535R	Módulo recto	245 x 35	365	8,11	1,283
36350E035R	Esquina recta	195 x 35	1	-	106,674
36350E535R	Esquina recta	245 x 35	1	-	117,639
36350P2	Perfil	35 x 24 x 2000	25	50	21,902



Perfil



Esquina



Montaje módulo recto/ondulado.



Montaje módulo estrecho.

ECOCANAL MODELO 200

ECOCANAL MODEL 200



Pincha QR para ver ficha técnica.



Negro
Black

Gris
Grey

Longitud 1 metro.
Salida inferior Ø75/90.
1 m. long.
Bottom outlet Ø75-90.

Polipropileno
Polypropylene

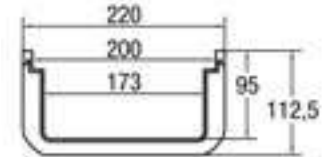

Ref. 36520

Referencia	Denominación	Peso g			€ u.
36520CN	Ecocanal negra de 200 de 1 metro de longitud	1.257	1	48	36,642
36520CG	Ecocanal gris de 200 de 1 metro de longitud	1.257	1	48	45,074

REJAS PARA ECOCANAL MODELO 200

GRATINGS FOR ECOCANAL MODEL 200



Negro
Black

Gris
Grey

REJAS PLÁSTICO

1. Pasarela en negro
Long. 0,5 m.
2. Pasarela en gris
Long. 0,5 m.

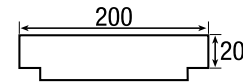

Ref. 36520

Referencia	Nº	Denominación	Long.	Aplicación			€ u.
36520RN	1	Reja Pasarela plástico negro	0,5 m.	Superficies peatonales	1	96	20,832
36520RG	2	Reja Pasarela plástico gris	0,5 m.	Superficies peatonales	1	96	22,568

ACCESORIOS PARA ECOCANAL MODELO 200

FASTENING DEVICES FOR ECOCANAL MODEL 200

Tapa Salida y Final Ø75
Outlet and stop end Ø75

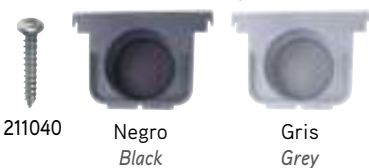

211040

Negro
Black

Gris
Grey

Ref. 36520

Referencia	Denominación	€ u.
36520TN	Tapa Salida y Final Ø75 negra	5,518
36520TG	Tapa Salida y Final Ø75 gris	5,828
211040	Tornillo 5,6 x 40 para pasarela de plástico	0,279

Las aplicaciones son meramente orientativas. El responsable de la obra decidirá la que necesite en función de las necesidades y del cumplimiento de la norma.
Uses are merely indicative. The responsible for the building work is the one to decide depending on needs and in accordance to Norm.

MÓDULO CANAL 130

130 CHANNEL MODULE



Pincha QR para ver ficha técnica.

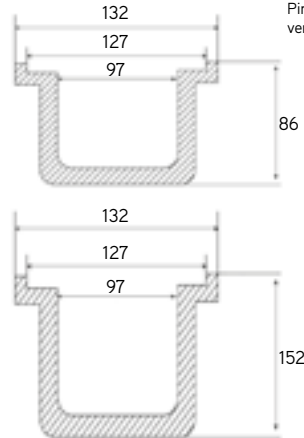

Ref. 36130

Referencia	D	M (mm)	Ø Salida vertical			€ u.
36130M75	Módulo canal 0,5 m	130 x 75 x 500	50	1	24	9,478
36130M140	Módulo canal 0,5 m	130 x 140 x 500	50	1	18	15,653



REJA PARA MÓDULO CANAL 130

GRATING FOR 130 CHANNEL MODULE

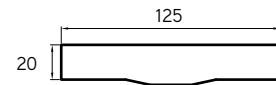
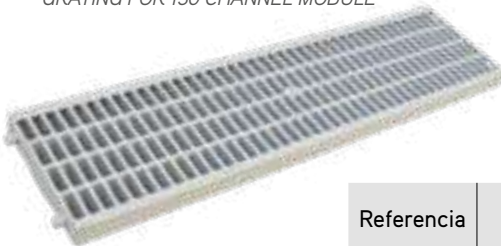

Ref. 36130

Referencia	D	M (mm)			€ u.
36130RR	Rejilla reforzada 0,5 m	130 x 500	1	20	9,443



Se recomienda utilizar la rejilla montada en su canal.

ACCESORIOS MÓDULO CANAL 130

FASTENING DEVICES FOR 130 CHANNEL MODULE

Ref. 36130



Referencia	D	M (mm)	Ø Salida vertical		€ u.
36130R4V	Racord 3 vías para canal	130 x 75	50	1	6,903
36130R140	Racord 3 vías para canal	130 x 140	50	1	11,233

Ref. 36130



Ø50

Referencia	D	M (mm)	Ø Salida horizontal		€ u.
36130TSM	Tapa salida módulo para canal	130 x 75	50	1	1,937
36130T140	Tapa salida módulo para canal	130 x 140	75-90	1	3,078



MÓDULO CANAL DE 200

200 CHANNEL MODULE

Pincha QR para ver ficha técnica.

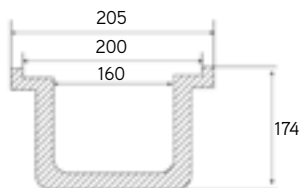

Ref. 36130



Referencia	D	M (mm)	Ø Salida vertical			€ u.
36130M200	Módulo canal 0,5 m	200 x 160 x 500	75-90	1	10	19,148

REJA PARA MÓDULO CANAL 200

GRATING FOR 200 CHANNEL MODULE

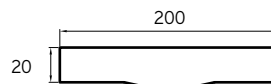
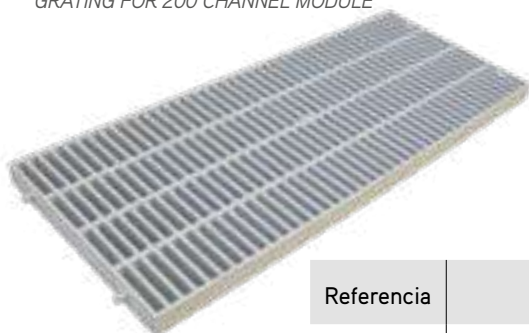

Ref. 36130



Referencia	D	M (mm)			€ u.
36130RR200	Rejilla reforzada 0,5 m	200 x 500	1	20	21,128

Se recomienda utilizar la rejilla montada en su canal.

ACCESORIOS MÓDULO CANAL 200

FASTENING DEVICES FOR 200 CHANNEL MODULE

Ref. 36130



Referencia	D	M (mm)	Ø Salida vertical		€ u.
36130R200	Racord 3 vías	200 x 175	50-75	1	14,202



Ref. 36130

Referencia	D	M (mm)	Ø Salida horizontal		€ u.
36130T200	Tapa Inicio y final	200 x 175	110	1	4,793



Soportes de canalón



Ref. 7100D | Pág. 116



Ref. 7100F | Pág. 116



Ref. 7100P | Pág. 116



Ref. 7100T | Pág. 116



Ref. 7100S | Pág. 116



Ref. 7100N | Pág. 117



Ref. 7100J | Pág. 117



Ref. 7101 | Pág. 117



Ref. 7100FCUN | Pág. 117

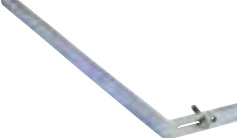

Ref. 7100A | Pág. 118

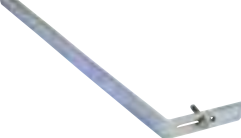

Ref. 7100B | Pág. 118



Ref. 7100C | Pág. 118



Ref. 7100E | Pág. 118



Ref. 7100H | Pág. 118



Ref. 7110 | Pág. 119



Ref. 7200 | Pág. 119



Ref. 7210 | Pág. 119



Ref. 7300 | Pág. 119

SOPORTES EN ACERO CINCADO PARA MÓDULO CON TORNILLOS Y TUERCAS

ZINC PLATED GUTTER SUPPORT WITH SCREWS AND NUTS

Ref. 7100

Pincha QR para ver ficha técnica.



Modelo patentado
Patented model

Referencia	Modelo	D (mm)			€ u.
7100D	D	Soporte curvado placa 25 x 3,5	100	4200	3,327
7100F	F	Soporte curvado teja 25 x 3,5	100	3200	3,789

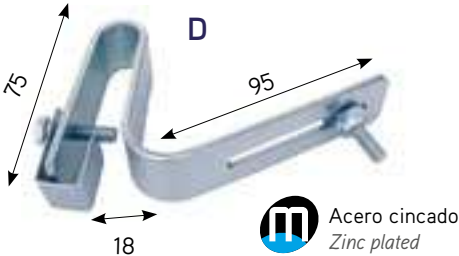

Modelo patentado
Patented model

Acero cincado
Zinc plated

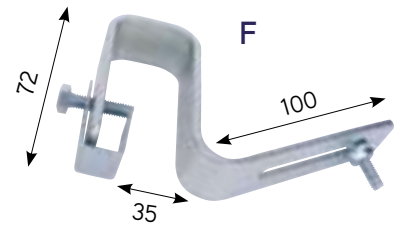

Equipado con tornillos y tuercas no montados. Van en bolsa aparte.
Equipped with screws and nuts. They are in separate bag.

SOPORTES ACERO CINCADO

ZINC PLATED STEEL SUPPORT

Ref. 7100

Pincha QR para ver ficha técnica.



Referencia	Modelo	D (mm)			€ u.
7100P203	P	Soporte curvado placa 20 x 3	100	3200	2,190
7100T203	T	Soporte curvado teja 20 x 3	100	3200	2,293

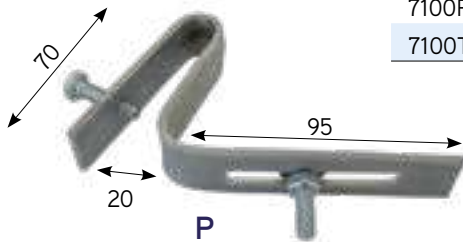

Acero cincado
Zinc plated

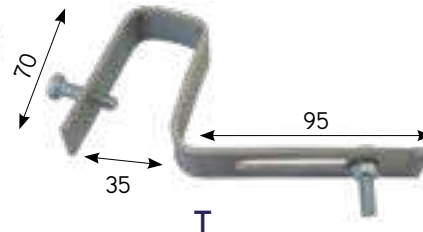

Equipado con tornillos y tuercas no montados. Van en bolsa aparte.
Equipped with screws and nuts. They are in separate bag.

SOPORTE EN ACERO CINCADO PARA MÓDULO CON TORNILLOS Y TUERCAS, ESPECIAL SANDWICH

ZINC PLATED STEEL GUTTER SUPPORT WITH SCREWS AND NUTS

Ref. 7100

Pincha QR para ver ficha técnica.



Referencia	Modelo	D (mm)			€ u.
7100S	S	Curvado Sandwich 23 x 3	100	3000	5,800

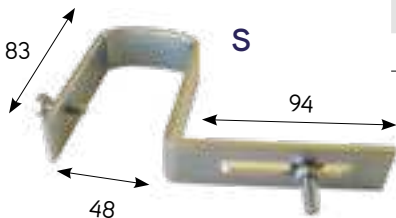

Acero cincado
Zinc plated

Equipado con tornillos y tuercas no montados. Van en bolsa aparte.
Equipped with screws and nuts. They are in separate bag.

SOPORTE EN ACERO CINCATO PARA MÓDULO DE PLÁSTICO CON TORNILLOS Y TUERCAS

ZINC PLATED STEEL SUPPORT FOR PLASTIC GUTTER WITH SCREWS AND NUTS

Ref. 7100

Pincha QR para ver ficha técnica.

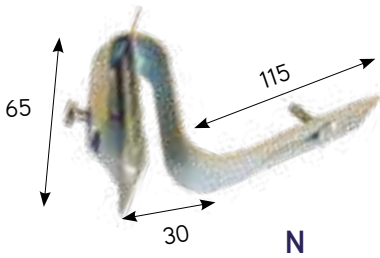

N

Acero cincado
Zinc plated

Referencia	Modelo	D (mm)		€ u.
7100N	N	Soporte curvado niko 25 x 2,5	100	5,880

Especialmente indicado para módulos de plástico con ranura interna. Tornillos y tuercas no montados. Van en bolsa aparte.
Especially for plastic fastening gutter screws and nuts mounted. They are in separate bag.

SOPORTE EN ACERO CINCATO REGULABLE CON TORNILLOS Y TUERCAS

ADJUSTABLE ZINC PLATED STEEL SUPPORT WITH SCREWS AND NUTS

Ref. 7100

Pincha QR para ver ficha técnica.

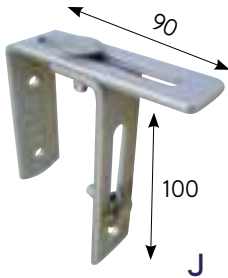

J

Acero cincado
Zinc plated

Referencia	Modelo	D (mm)		€ u.
7100J	J	Soporte 24 x 4 Regulable	100	10,560

Se suministra en bolsos con dos conjuntos por bolsa con tornillos y tuercas.
Screws and nuts mounted. They are in separate bag.

Regulable hasta 63 mm.
Adjustable from 0 to 63 mm.

TORNILLO CABEZA REDONDA CUELLO CUADRADO CON TUERCA

ROUND HEAD & SQUARE NECK SCREW WITH NUT

Ref. 7101

Pincha QR para ver ficha técnica.



Acero cincado
Zinc plated

Referencia	R/L (mm)		€ u.
7101625	6 x 25	300	0,315

SOPORTE EN COBRE PARA MÓDULO CON TORNILLOS Y TUERCAS

COPPER GUTTER SUPPORT WITH SCREWS AND NUTS

* Ref. 7100

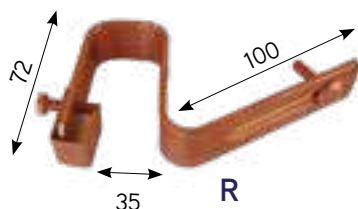

R

Cobre
Copper



Modelo patentado
Patented model

Equipado con tornillos y tuercas montados en el soporte.
Equipped with screws and nuts mounted on the support

Referencia	Modelo	D (mm)			€ u.
7100FCUN	R	Cobre curvado teja 25 x 3,5	100	3500	30,490

* Hasta final de existencias / *Until end of stocks.*

SOPORTE ANGULAR PARA MÓDULO CON TORNILLOS Y TUERCAS

ANGULAR METAL SUPPORT GUTTER WITH SCREWS AND NUTS

Pincha QR para ver ficha técnica.

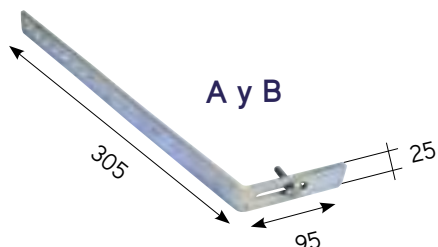

Ref. 7100

Referencia	Modelo	D (mm)		€ u.
7100A	A	Angular de 400 x 25 x 2,5	50	3,457
7100B	B	Angular de 400 x 25 x 4	50	3,888

Con tornillos montados en los soportes.
With screws mounted on the support.

SOPORTE ANGULAR PARA MÓDULO CON TORNILLOS Y TUERCAS

ANGULAR METAL SUPPORT GUTTER WITH SCREWS AND NUTS

Pincha QR para ver ficha técnica.

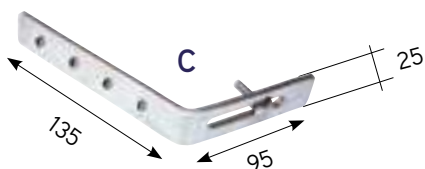

Ref. 7100C

Referencia	Modelo	D (mm)		€ u.
7100C	C	Angular de 230 x 25 x 4	100	3,217

Con tornillos montados en los soportes.
With screws mounted on the support.

SOPORTE RECTO PARA MÓDULO CON TORNILLOS Y TUERCAS

STRAIGHT METAL SUPPORT GUTTER WITH SCREWS AND NUTS

Pincha QR para ver ficha técnica.

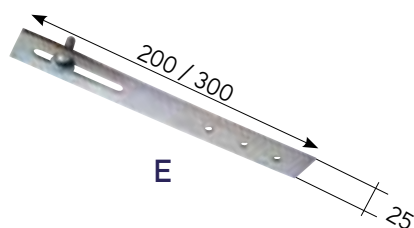

Ref. 7100E

Referencia	Modelo	D (mm)		€ u.
7100E200	E	Recto de 200 x 25 x 2,5	100	1,694
7100E300	E	Recto de 300 x 25 x 2,5	100	1,848

Con tornillos montados en los soportes.
With screws mounted on the support.

SOPORTE CLAVAR PARA MÓDULO

METAL SUPPORT GUTTER WITH SCREWS AND NUTS

Pincha QR para ver ficha técnica.

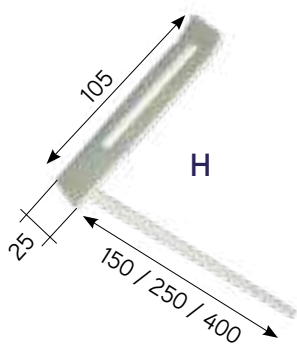

Ref. 7100H

Referencia	Modelo	D (mm)		€ u.
7100H150	H	Soporte de 150 x 105 x 25 x 3	100	9,037
7100H250	H	Soporte de 250 x 105 x 25 x 3	100	9,331
7100H400	H	Soporte de 400 x 105 x 25 x 3	100	9,765

Clavo cuadrado de 10 x 10 / Square clave 10 x 10.

MÓDULO METÁLICO PARA CANALÓN PVC

METAL SUPPORT FOR PVC GUTTER



Acero cincado
Zinc plated

Ref. 7110

Pincha QR para ver ficha técnica.



Referencia	D		€ u.
711025	Epe-25	50	2,247
711033	Epe-33	50	2,859

GANCHO PARA CANALÓN TIPO EPE

MORTISE HOOK FOR EPE TYPE GUTTER



Acero cincado
Zinc plated

Ref. 7200

Pincha QR para ver ficha técnica.



Referencia	D		€ u.
720025	Epe-25	50	2,726
720033	Epe-33	50	3,143

GANCHO RECTO PARA CANALÓN TIPO EPE Y AISCONDEL

STRAIGHT HOOK FOR EPE AND AISCONDEL TYPE GUTTER

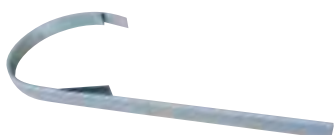

Acero cincado
Zinc plated

Ref. 7210

Pincha QR para ver ficha técnica.



Referencia	D		€ u.
721025	Epe 25 y Aiscondel 125	50	2,699
721033	Epe 33 y Aiscondel 150	50	3,158

CARTELA PARA CANALÓN TIPO EPE

BRACKET FOR EPE TYPE GUTTER



Acero cincado
Zinc plated

Ref. 7300

Pincha QR para ver ficha técnica.



Referencia	D		€ u.
730025	Epe-25	50	2,586
730033	Epe-33	50	3,056

Fijación de cubierta



Ref. 8100 | Pág. 121



Ref. 8200 | Pág. 121

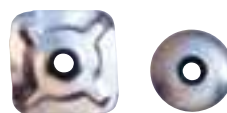

Ref. 8300 | Pág. 122



Ref. 8500 | Pág. 122



Ref. 8600 | Pág. 122



Ref. 8400 | Pág. 122



Ref. 9500 | Pág. 122



Ref. 9210 | Pág. 123



Ref. 9210 | Pág. 123

GANCHOS CON TUERCA Ø6

HOOK WITH NUT Ø6

Ref. 8100 Ø6

Pincha QR para ver ficha técnica.

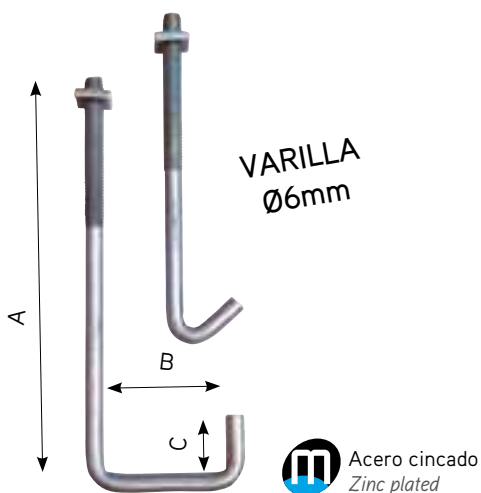

Cada gancho se suministra con su tuerca.
Medidas especiales bajo demanda.
Podemos suministrar en Acero Inoxidable.
*Each hook is supplied with nut.
Special measures to order.
We can also supply stainless steel finish.*

Referencia	M (mm) A x B x C	Ø (mm)		€ u.
8100125	125-20	6	500	0,707
810010044	100-44-20	6	500	0,699
810011044	110-44-20	6	500	0,732
810012044	120-44-20	6	500	0,734
810013044	130-44-20	6	500	0,751
810014044	140-44-20	6	500	0,784
810015044	150-44-20	6	500	0,807
810015052	150-52-20	6	500	0,824
810017044	170-44-20	6	250	0,848
810017052	170-52-20	6	250	0,863
810019052	190-52-20	6	250	0,910
810021060	210-60-20	6	250	0,975
8100210115	210-115-20	6	250	1,104
810023068	230-68-20	6	250	1,044
8100230105	230-105-20	6	250	1,135
8100250105	250-105-20	6	250	1,186
8100280105	280-105-20	6	250	1,273
8100280110	280-110-20	6	250	1,299
8100280115	280-115-20	6	250	1,329
8100280120	280-120-20	6	250	1,342
8100300105	300-105-20	6	250	1,329
8100300115	300-115-20	6	250	1,390

GANCHOS CON TUERCA Ø7

HOOK WITH NUT Ø7

Ref. 8200 Ø7

Pincha QR para ver ficha técnica.

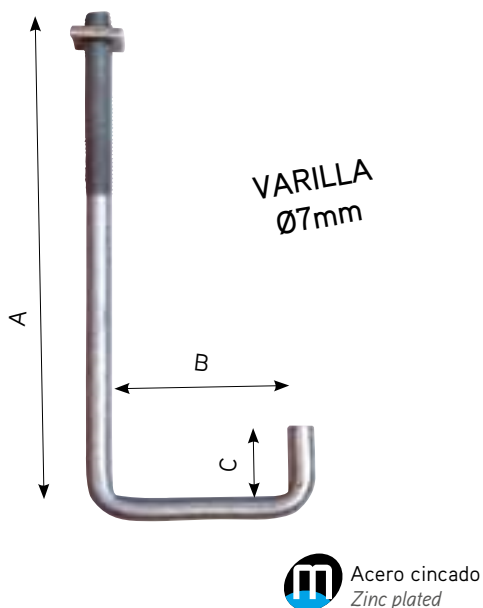

Cada gancho se suministra con su tuerca.
Medidas especiales bajo demanda.
Podemos suministrar en Acero Inoxidable.
*Each hook is supplied with nut.
Special measures to order.
We can also supply stainless steel finish.*

Referencia	M (mm) A x B x C	Ø (mm)		€ u.
820010044	100-44-20	7	250	0,998
820012044	120-44-20	7	250	1,007
820013044	130-44-20	7	250	1,050
820014044	140-44-20	7	250	1,083
820015044	150-44-20	7	250	1,113
820015052	150-52-20	7	250	1,132
820017044	170-44-20	7	250	1,218
820017052	170-52-20	7	250	1,175
820019052	190-52-20	7	250	1,227
820021060	210-60-20	7	250	1,251
8200210115	210-115-20	7	250	1,547
820023068	230-68-20	7	250	1,509
8200230105	230-105-20	7	250	1,547
8200250105	250-105-20	7	250	1,646
8200250115	250-115-20	7	250	1,674
8200280105	280-105-20	7	250	1,753
8200280110	280-110-20	7	250	1,818
8200280115	280-115-20	7	250	1,821
8200300105	300-105-20	7	250	1,862
8200300115	300-115-20	7	250	1,929

ARANDELA

WASHER

Ref. 8300

Pincha QR para ver ficha técnica.

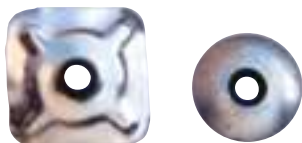

Referencia	D	Ø int. (mm)	Ø ext. (mm)		€ u.
830025	Hierro-plomo	8	25	250	0,894
830030	Mix-Redonda	8	30	125	0,146
830040	Mix-Cuadrada	8	40	125	0,171

Acero cincado
Zinc plated

TORNILLO SALOMÓNICO

WOOD SCREW

Ref. 8500

Pincha QR para ver ficha técnica.



Acero cincado
Zinc plated

Referencia	Ø / L (mm)		€ u.
* 8500110	22/110	500	0,936
8500130	23/130	250	0,594

*Hasta final de existencias / Until end of stocks.

APOYAONDAS

WAVE SUPPORT

Ref. 8600

Pincha QR para ver ficha técnica.



Acero cincado
Zinc plated

Referencia	D		€ u.
8600M	Mediana	250	0,281
8600G	Grande	250	0,608

TUERCA CUADRADA PARA GANCHO

SQUARE NUT FOR HOOK

Ref. 8400

Pincha QR para ver ficha técnica.



Acero cincado
Zinc plated

Referencia	Ø gancho (mm)		€ u.
84007	6	250	0,118
84008	7	250	0,120

TORNILLO AUTORROSCANTE CON ARANDELA Ø16

TAPPING SCREW

Ref. 9500

Pincha QR para ver ficha técnica.



Referencia	D	Ø (mm)	L (mm)		€ u.
95006319	6,3 x 19	6,3	19	250	0,268
95006325	6,3 x 25	6,3	25	250	0,289
95006332	6,3 x 32	6,3	32	250	0,318
95006340	6,3 x 40	6,3	40	250	0,356
95006350	6,3 x 50	6,3	50	250	0,389
95006360	6,3 x 60	6,3	60	250	0,473
950063110	6,3 x 110	6,3	110	250	0,946
950063120	6,3 x 120	6,3	120	250	1,050

Acero cincado
Zinc plated

Otras medidas consultar.
Other measures, please consult.

TORNILLO PUNTA BROCA CON ARANDELA Ø16

SCREW DRILL BIT TIP WITH WASHER Ø16



Ref. 9210

Pincha QR para ver ficha técnica.

Referencia	D	L (mm)		€ u.
921055060	5,5/6,3 x 60	60	100	0,401
921055082	5,5/6,3 x 82	82	100	0,558
921055098	5,5/6,3 x 98	98	100	0,695
921055115	5,5/6,3 x 115	115	100	0,742

Ø punta broca 5,5 mm
Ø rosca 6,3 mm

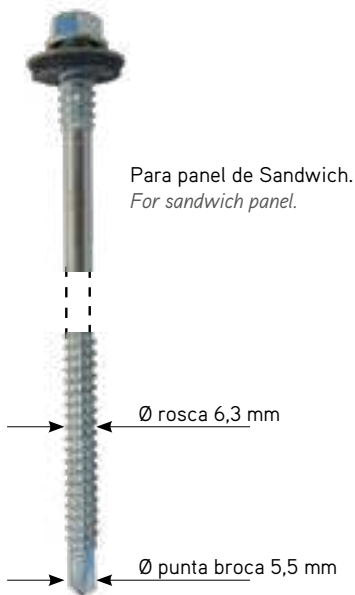

Acero cincado / Bicromado
Zinc plated

Otras medidas consultar.
Other measures, please consult.

TORNILLO PUNTA BROCA CON ARANDELA Ø16

SCREW DRILL BIT TIP WITH WASHER Ø16



Ref. 9210

Pincha QR para ver ficha técnica.

Referencia	D	Ø (mm)	L (mm)		€ u.
92104816	4,8 x 16	4,8	16	500	0,184
92104819	4,8 x 19	4,8	19	500	0,134
92105519	5,5 x 19	5,5	19	500	0,184
92105522	5,5 x 22	5,5	22	500	0,156
92106325	6,3 x 25	6,3	25	500	0,224



Acero cincado
Zinc plated

Otras medidas consultar.
Other measures, please consult.

Fundición de aluminio



Ref. 6100 | Pág. 125



Ref. 6101 | Pág. 125



Ref. 6140B | Pág. 125



Ref. 6140BR | Pág. 125



Ref. 6120 T.C.C. | Pág. 126



Ref. 6120LL | Pág. 126



Ref. 6120CCLL | Pág. 126



Ref. 61115 | Pág. 126



Ref. 6110 | Pág. 126

SUMIDERO DE ALUMINIO

ALUMINIUM DRAIN

Ref. 6100

Pincha QR para ver ficha técnica.



Referencia	M (cm)	Ø Tapa (cm)	Ø salida (mm)		€ u.
610010	10 x 10 x 5,0	8,9	40	1	14,880
610015	15 x 15 x 6,2	11,4	50	1	20,340
610020	20 x 20 x 6,5	15,0	75	1	36,300
610025	25 x 25 x 7,0	18,8	75	1	58,020
610030	30 x 30 x 6,5	21,8	90	1	77,700



SUMIDERO ECONÓMICO

ECONOMIC ALUMINIUM DRAIN

Ref. 6101

Pincha QR para ver ficha técnica.



Referencia	M (cm)	Ø Tapa (cm)	Ø salida (mm)		€ u.
610140	40 x 40 x 6,5	28,6	125	1	94,550



TAPA REGISTRO DE ALUMINIO CON MARCO HERMETICA

WATERTIGHT ALUMINIUM MANHOLE COVER & FRAME

Ref. 6140B

Pincha QR para ver ficha técnica.



Referencia	M (cm)		€ u.
6140B30	30 x 30	1	215,940
6140B40	40 x 40	1	361,120
6140B50	50 x 50	1	496,540
6140B60	60 x 60	1	1.318,820



Otras medidas consultar.
Other measures please consult.

TAPA REGISTRO DE ALUMINIO CON MARCO HERMETICA Y RELLENABLE

REFILLABLE WATERTIGHT ALUMINIUM MANHOLE COVER AND FRAME

Ref. 6140BR



Referencia	M (cm)		€ u.
6140BR30	30 x 30	1	427,000
6140BR40	40 x 40	1	591,700
6140BR50	50 x 50	1	793,000
6140BR60	60 x 60	1	1.311,500



Altura de relleno interior 3 cm.

TAPAS DE CONTADOR PARA PARED EN FUNDICIÓN DE ALUMINIO

MAINHOLE COVER FOR WALL

Ref. 6120

Pincha QR para ver ficha técnica.



T.C.C. cerradura y llave con cuadradillo incluida



Referencia	D	M (cm)		€ u.
612035	T.C.C. 35	22 x 35 x 2,5	1	34,860
612040	T.C.C. 40	28 x 38 x 2,5	1	45,420
612050	T.C.C. 50	28 x 53 x 2,5	1	74,360

Referencia	D		€ u.
6120LL	Llave T.C.C.	1	2,050
6120CCLL	Cerradura T.C.C. con llave	1	7,000



T.C.C. 35 con ventanilla



6120LL



6120CCLL

TAPAS REGISTRO PARA SUELO EN ALUMINIO CON MARCO CIERRE POR TORNILLO ALLEN INOXIDABLE

ALUMINIUM MANHOLE COVER & FRAME WITH ALLEN TYPE LOCK

Ref. 6110



Referencia	D	M (cm)		€ u.
611020	R.A. 20	20 x 20 x 2,5	1	23,760
611030	R.A. 30	30 x 30 x 3	1	64,025
611040	R.A. 40	40 x 40 x 3,5	1	104,975

Referencia	D		€ u.
61115	Llave allen nº 5	1	0,254



61115



Tapas y puertas de contador

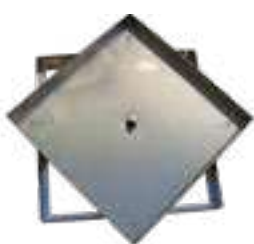

Ref. 37500I | Pág. 128



Ref. 37500 | Pág. 128

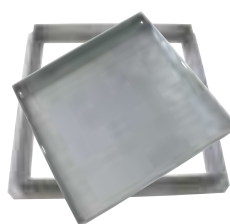

Ref. 37600 | Pág. 128



Ref. 37400 | Pág. 129



Ref. 35100 | Pág. 129



Ref. 37700 | Pág. 129



Ref. 37800G | Pág. 130



Ref. 37800I | Pág. 130



Ref. 35900 | Pág. 130



Ref. 35900 | Pág. 130



Ref. 35900 | Pág. 131



Ref. 35900 | Pág. 131



Ref. 35500 | Pág. 131



Ref. 35500 | Pág. 131

TAPA RELLENABLE METÁLICA ACERO INOX AISI 304

REFILLABLE STAINLESS STEEL AISI 304 COVER



Ref. 37500I

Pincha QR para ver ficha técnica.



Referencia	M (cm)		€ u.
375003333I	33 x 33 x 4,5	1	82,073
375004343I	43 x 43 x 4,5	1	115,789
375005353I	53 x 53 x 4,5	1	157,592

Altura de relleno 4 cm.



Acero inoxidable Aisi 304
Stainless steel Aisi 304

TAPA RELLENABLE GALVANIZADA 10 / 10

REFILLABLE GALVANIZED 10 / 10 COVER



Ref. 37500

Pincha QR para ver ficha técnica.



Referencia	M (cm)		€ u.
375003333	33 x 33 x 5	1	31,159
375004343	43 x 43 x 5	1	43,967
375005353	53 x 53 x 5	1	58,591
375006363	63 x 63 x 5	1	86,117

Altura de relleno 4,5 cm.



Acero galvanizado
Galvanized steel

TAPA RELLENABLE GALVANIZADA 20 / 10 REFORZADA

REFILLABLE GALVANIZED 20 / 10 COVER REINFORCED

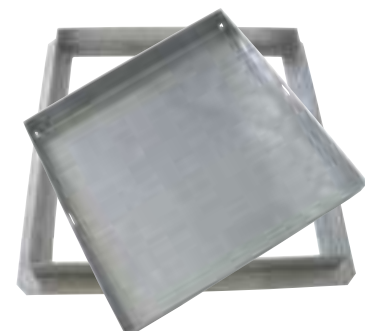

Ref. 37600

Pincha QR para ver ficha técnica.



Referencia	M (cm)		€ u.
376003030	30 x 30 x 5	1	91,861
376004040	40 x 40 x 5	1	134,780
376005050	50 x 50 x 5	1	182,007
376006060	60 x 60 x 5	1	238,977

Altura de relleno 4 cm.



Acero galvanizado
Galvanized steel

TAPA CISTERNA GALVANIZADA

GALVANIZED TANK COVER

Pincha QR para ver ficha técnica.



Ref. 37400

Referencia	M (cm)		€ u.
3740040	40 x 40	1	135,767
3740050	50 x 50	1	196,335
3740060	60 x 60	1	269,489



Acero galvanizado
Galvanized steel

TAPA ESTANCA CON MARCO EN FIBRA DE VIDRIO Y RESINA

FIBREGLASS AND RESIN COVER + FRAME

Pincha QR para ver ficha técnica.



Ref. 35100

Referencia	M (cm)	Resistencia		€ u.
3510040	40 x 40	60 kN	1	164,700

Características:

- Resistente a la corrosión
- Grado de protección UNE 20 324-93
- Especial aceras y jardines
- Se puede señalar poniendo alumbrado público, tráfico, etc.

Characteristics:

- Corrosion resistant.
- UNE 20 324-93 protection standard.
- Specially suitable for pavement and garden.
- It can be engraved as "alumbrado público, tráfico, etc."



Poliéster reforzado con fibra de vidrio
Reinforced polyester with fiberglass

TAPA DE CONTADOR DE ACERO RELLENABLE PARA PARED

REFILLABLE MANHOLE COVER FOR WALL

Pincha QR para ver ficha técnica.

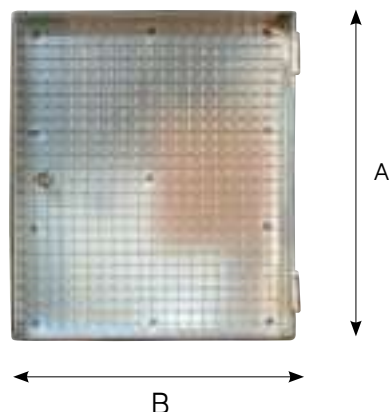

Ref. 37700

Referencia	A x B (cm)	Material		€ u.
377005040	50 x 40	Acero galvanizado	1	154,451

Con cerradura y llave con cuadradillo incluida.
With lock and key included.



Acero galvanizado
Galvanized Steel

TAPAS DE CONTADOR DE ACERO PARA PARED

MANHOLE COVER FOR WALL

Ref. 37800 Pincha QR para ver ficha técnica.

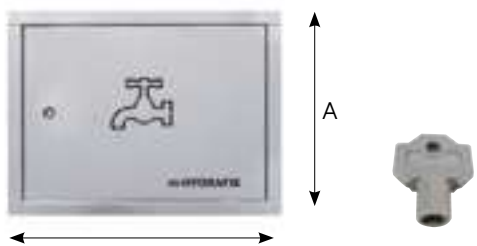

Con cerradura y llave con cuadradillo incluida.
With lock and key included.

Referencia	A x B (cm)	Material		€ u.
37800G	30 x 40	Acero galvanizado	1	61,787
37800I	30 x 40	Acero inoxidable	1	127,516

Bajo pedido se suministran con la inscripción: AIGUA. Hasta fin de existencias. Consulte precio.

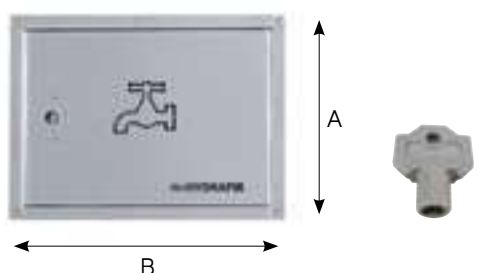
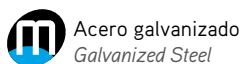

Con cerradura y llave con cuadradillo incluida.
With lock and key included.



TAPA DE CONTADOR CON MARCO, VISOR Y CERRADURA EN POLIESTIRENO

MANHOLE COVER FOR WALL

Ref. 35900 Pincha QR para ver ficha técnica.

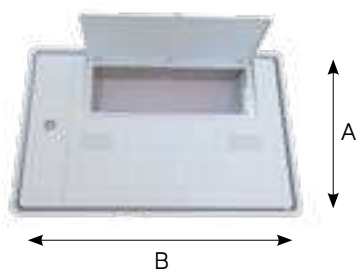

Con cerradura y llave triangular incluida.
With lock and key included.

Referencia	A x B x C (cm)		€ u.
35900MV	49 x 33 x 3	1	44,400



TAPA DE CONTADOR CON CAJA, VISOR Y CERRADURA EN POLIESTIRENO

MANHOLE COVER FOR WALL

Ref. 35900 Pincha QR para ver ficha técnica.

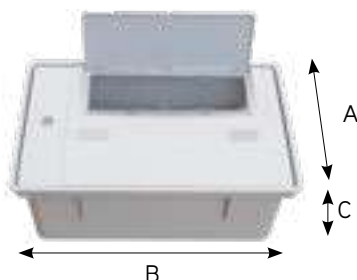

Con cerradura y llave triangular incluida.
With lock and key included.

Referencia	A x B x C (cm)		€ u.
35900CV	49 x 33 x 18	1	54,675



TAPA CONTADOR CON MARCO Y CERRADURA EN POLIESTIRENO

WATER METER COVER WITH FRAME AND POLYSTYRENE LOCK

Ref. 35900

Pincha QR para ver ficha técnica.

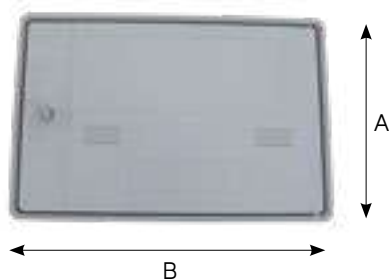

Referencia	A x B x C (cm)		€ u.
35900M4933	49 x 33 x 3	1	44,400



Poliestireno
Polystyrene



Llave triangular incluida.
Triangular key.

TAPA CONTADOR CON CAJA Y CERRADURA EN POLIESTIRENO

WATER METER COVER WITH BOX AND POLYESTER LOCK

Ref. 35900

Pincha QR para ver ficha técnica.



Poliestireno
Polystyrene



Llave triangular incluida.
Triangular key.

Pincha QR para ver ficha técnica.



TAPA CONTADOR CON MARCO Y CERRADURA EN POLIÉSTER REFORZADO CON FIBRA DE VIDRIO

WATER METER COVER WITH FRAME AND POLYSTYRENE LOCK

Ref. 35500



Referencia	A x B x C (cm)		€ u.
35500MHAR1	43 x 31,5 x 6	1	109,190
35500MXA	57,8 x 69,8 x 10,5	1	236,680



Poliéster
Polyester



Llave triangular incluida.
Triangular key.

Pincha QR para ver ficha técnica.



TAPA CONTADOR CON CAJA Y CERRADURA EN POLIÉSTER REFORZADO CON FIBRA DE VIDRIO

WATER METER COVER WITH BOX AND POLYESTER LOCK

Ref. 35500

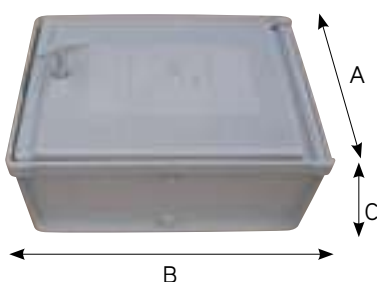

Referencia	A x B x C (cm)		€ u.
35500MHA1	43 x 31,5 x 18	1	112,240
35500MXAG	57,8 x 69,8 x 24	1	260,470



Poliéster
Polyester



Llave triangular incluida.
Triangular key.

Fundición de hierro

Tipo A

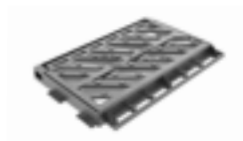

Ref. 6700 | Pág. 133

Tipo B

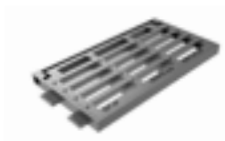

Ref. 6700 | Pág. 133

Tipo C

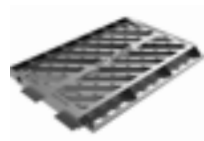

Ref. 6700 | Pág. 133



Ref. 6700SP | Pág. 133



Ref. 6610 | Pág. 134



Ref. 6620 | Pág. 134



Ref. 6620C | Pág. 134



Ref. 6640 | Pág. 134

Tapa Articulada Futura



Ref. 6510 | Pág. 135

Tapa Transit



Ref. 6510 | Pág. 135

Tapa Redonda



Ref. 6510 | Pág. 135

Tapa Articulada



Ref. 6510 | Pág. 135

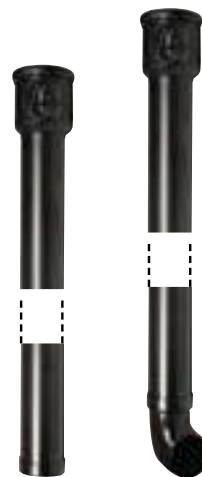

Ref. 6900 | Pág. 136



Ref. 6800 | Pág. 135



Ref. 6800L | Pág. 135



Ref. 11400 | Pág. 136

IMBORNAL CON MARCO

GRATING WITH FRAME



Ref. 6700

Pincha QR para ver ficha técnica.

Referencia	D	T	M (cm) A x B x C	Clase	€ u.
67000745	Delta 45	A	455 x 255 x 37	C250	150,345
67000746	Delta 46	B	460 x 240 x 30	C250	181,675
67000766	Delta 50	C	565 x 300 x 40	250 KN	207,610

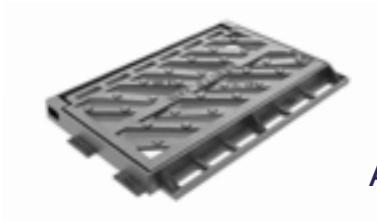

A



B

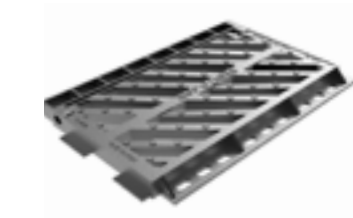

C

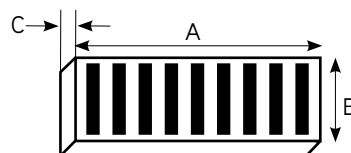

- Compatible con el sumidero sifónico ref. 6700SP.
Compatible with drain ref. 6700SP.

Todos los imbornales son abatibles y registrables.
Su colocación debe ser horizontal, según dibujo.
All gratings are foldaway except. Horizontal installation only, as in drawing.



SUMIDERO SIFÓNICO P.P.

SIPHON P.P. DRAIN



Ref. 6700SP

Pincha QR para ver ficha técnica.

Referencia	M (mm)		€ u.
6700SP460	500 x 460 x 250 (Ø200)	1	121,940



Se puede utilizar con un imbornal Delta-46 de referencia 67000746.
It can be used with grating Delta-46 on 67000746.

Las medidas indicadas son aproximadas. Todas las tapas, imbornales, etc., se suministrarán con su marco incluido en el precio.
All sizes listed are only approximate. All covers, grating, etc., will be supplied with their corresponding frame, included in the price shown.

TAPA CUADRADA CON MARCO B125

SQUARE COVER WITH FRAME B125

Pincha QR para ver ficha técnica.



Ref. 6610

Referencia	D	M (mm)	Clase	€ u.
661025	25	250 x 250	B125	41,070
661030	30	300 x 300	B125	44,067
661040	40	400 x 400	B125	92,574
661050	50	500 x 500	B125	158,730
661060	60	600 x 600	B125	182,318
661070	70	700 x 700	B125	387,205
661080	80	800 x 800	B125	577,720
661090	90	900 x 900	B125	879,710

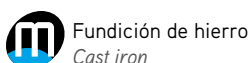

TAPA CUADRADA CON MARCO 250 KN

SQUARE COVER WITH FRAME 125/250 KN

Pincha QR para ver ficha técnica.



Ref. 6620K

Referencia	D	M (mm)	Clase	€ u.
6620K40	K40	400 x 400	250KN	145,440
6620K50	K50	500 x 500	250KN	278,760
6620K60	K60	600 x 600	250KN	375,720

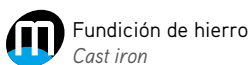

TAPA CUADRADA REFORZADA CON MARCO C250

REINFORCED SQUARE COVER WITH FRAME C250

Pincha QR para ver ficha técnica.



Ref. 6620C

Referencia	D	M (mm)	Clase	€ u.
6620C40	C40	400 x 400	C250	202,560
6620C50	C50	500 x 500	C250	248,400
6620C60	C60	600 x 600	C250	405,000

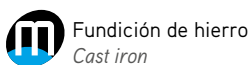

TAPA CUADRADA REFORZADA CON MARCO D400

REINFORCED SQUARE COVER WITH FRAME D400

Pincha QR para ver ficha técnica.



Ref. 6640D

Referencia	D	M (mm)	Clase	€ u.
6640D40	40	400 x 400	D400	245,700
6640D50	50	500 x 500	D400	360,685
6640D60	60	600 x 600	D400	565,760

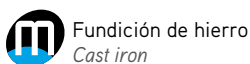

Las medidas indicadas son aproximadas. Todas las tapas, imbornales, etc., se suministrarán con su marco incluido en el precio.
All sizes listed are only approximate. All covers, grating, etc., will be supplied with their corresponding frame, included in the price shown.

TAPA REDONDA CON MARCO

ROUND COVER WITH FRAME

Ref. 6510

Referencia	D	Ø tapa (mm)	Ø altura marco (mm)	Clase	€ u.
6510F8DU	Tapa redonda	570	670 x 40	250KN	184,680
6510T2060A	Transit 2.0-60A	585	700 x 45	B125	212,121
6510T2061N	Articulada 2.0-61N	620	805 x 85	C250	347,375
• 6510T2063	Articulada Futura	625	825 x 90	D400	367,743



Fundición de hierro
Cast iron

• Con junta de insonorización.

Pincha QR para
ver ficha técnica.



Tapa
Redonda

Pincha QR para
ver ficha técnica.



Tapa
Transit

Pincha QR para
ver ficha técnica.



Tapa
Articulada

Pincha QR para
ver ficha técnica.



Tapa Articulada
Futura

SUMIDERO DE HIERRO

CAST IRON DRAIN



Fundición de hierro
Cast iron

Ref. 6800

Pincha QR para
ver ficha técnica.



Referencia	M (cm)		€ u.
680015	15 x 15 x 5,5	1	22,890
680020	20 x 20 x 6	1	63,770
680025	25 x 25 x 7	1	87,360
680030	30 x 30 x 7,5	1	126,675
680040	40 x 40 x 12	1	164,625

SUMIDERO DE HIERRO LIGERO

LIGHT CAST IRON DRAIN



Fundición de hierro
Cast iron

Ref. 6800L

Pincha QR para
ver ficha técnica.



Referencia	M (cm)	Ø Tapa (cm)	Ø salida aprox. mm		€ u.
6800L20	20 x 20 x 6	15	63	1	39,000
6800L25	25 x 25 x 6	19	83	1	52,200
6800L30	30 x 30 x 6	22	97	1	87,000
6800L40	40 x 40 x 6	29	118	1	138,000

Las medidas indicadas son aproximadas. Todas las tapas, imbornales, etc., se suministrarán con su marco incluido en el precio.
All sizes listed are only approximate. All covers, grating, etc., will be supplied with their corresponding frame, included in the price shown.

TUBO BAJANTE DE CANALÓN EN HIERRO DE 2 M

DESCENDENT GUTTER 2 M



Ref. 6900

Pincha QR para ver ficha técnica.

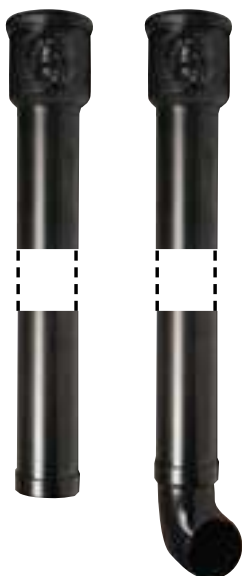

Referencia	Ø (mm)	L	€ u.
69000902A	90	1,92 m	484,740
69001102A	110	1,92 m	501,360

Ref. 690C (con codo)

Referencia	Ø (mm)	L	€ u.
690C0902A	90	2,05 m	587,535
690C1102A	110	2,05 m	662,545



No se recomienda conectar al alcantarillado. Sólo para bajante de agua de lluvia.
Connection to sewer system is not advised. Only for descendent of rain water use.

ABRAZADERA PARA EL TUBO BAJANTE DE FUNDICIÓN DE HIERRO

BLACK CLAMP FOR IRON CASTING DESCENDENT GUTTER



Ref. 11400

Pincha QR para ver ficha técnica.



+



10 x 100

+



Ø 12

Referencia	D	Ø (mm)	€ / bolsa
11400080	Bolsa abrazadera negra, taco y Dowell	80/90	12,529
11400100	Bolsa abrazadera negra, taco y Dowell	100	13,178
11400110	Bolsa abrazadera negra, taco y Dowell	110	15,260

Acero. Pintura epoxi negra
Steel epoxy paint black

Bolsa de un conjunto
1 set in each bag

Evacuación de agua en plástico



Ref. 36105E | Pág. 138



Ref. 36104TAM | Pág. 138



Ref. 36104S | Pág. 138



Ref. 36104R | Pág. 138



Ref. 36104 | Pág. 139



Ref. 36103 | Pág. 139



Ref. 36104TA | Pág. 139



Ref. 36104TN | Pág. 139



Ref. 36105 | Pág. 140



Ref. 36102 | Pág. 140



Ref. 36106 | Pág. 140

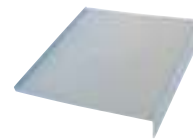

Ref. 36107 | Pág. 140



Ref. 36100 | Pág. 141



Ref. 36100H | Pág. 141



Ref. 36101 | Pág. 141

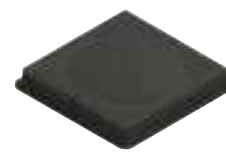

Ref. 38400T | Pág. 141



Ref. 36450 | Pág. 141



Ref. 36101S | Pág. 142



Ref. 36101A | Pág. 142



Ref. 36101B | Pág. 142

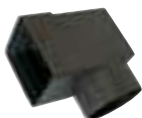

Ref. 36101C | Pág. 142



Ref. 36101D | Pág. 142



Ref. 36101 | Pág. 142



Ref. 36504 | Pág. 143



Ref. 36503 | Pág. 143



Ref. 36502 | Pág. 143



Ref. 36505 | Pág. 143



Ref. 36507 | Pág. 143

ARQUETA ELÉCTRICA CON TAPA

ELECTRIC CHEST WITH COVER

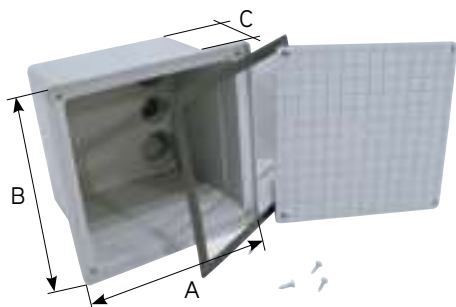

Ref. 36105E

Pincha QR para ver ficha técnica.



Referencia	M (mm) AxBxC		€ u.
36105E	275 x 275 x 245	1	35,890

Polipropileno
Polypropylene

TAPA CON ASAS Y MARCO

COVER WITH FRAME

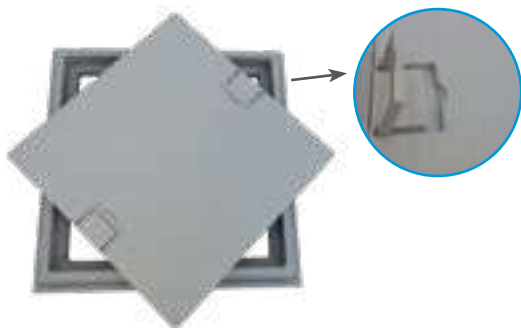

Ref. 36104TAM

Pincha QR para ver ficha técnica.



Referencia	M (mm) AxB		€ u.
36104TAM65	65 x 65	1	223,644

Polipropileno
Polypropylene

TAPA CON MARCO Y SUMIDERO

COVER WITH FRAME AND DRAIN



Ref. 36104S

Pincha QR para ver ficha técnica.



Referencia	M (mm)	Ø		€ u.
3610430S	300 x 300	50	1	34,280
3610440S	400 x 400	90	1	57,890

Polipropileno
Polypropylene

TAPA REGISTRO RELLENABLE CON MARCO

MANHOLE COVER AND FRAME



Ref. 36104R

Pincha QR para ver ficha técnica.



Referencia	M (mm)		€ u.
3610430R	300 x 300	1	20,202
3610440R	400 x 400	1	32,556

Polipropileno
Polypropylene

No se aceptarán reclamaciones por rotura pasadas 24 horas de la descarga del material en casa del cliente.
Claims are not accepted by breaking past 24 h of delivery of the material at the customer.

TAPA REFORZADA

REINFORCED COVER

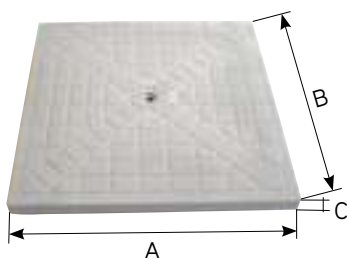

Ref. 36104

Pincha QR para ver ficha técnica.



Referencia	Para Marco/Arqueta	M (mm) AxBxC	Peso en Kg		€ u.
3610420	200 x 200	185 x 185 x 19	0,45	1	5,923
3610430	300 x 300	280 x 280 x 21	1,34	1	13,869
3610440	400 x 400	380 x 380 x 25	2,70	1	32,434
3610455	550 x 550	530 x 530 x 33	6,90	1	78,371



Polipropileno
Polypropylene

- Compatible con ref. 36102 y 36105.
Compatible with ref. 36102 and 36105.

REJILLA REFORZADA

REINFORCED GRATING

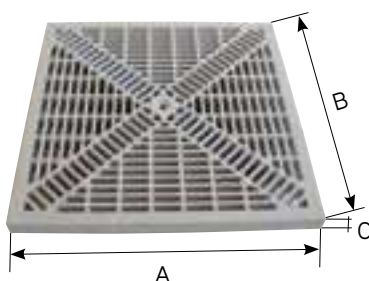

Ref. 36103

Pincha QR para ver ficha técnica.



Referencia	Para Marco/Arqueta	M (mm) AxBxC	Peso Kg		€ u.
3610320	200 x 200	185 x 185 x 19	0,45	1	8,455
3610330	300 x 300	280 x 280 x 21	1,34	1	19,936
3610340	400 x 400	380 x 380 x 25	2,70	1	30,338
3610355	550 x 550	530 x 530 x 33	6,90	1	82,707



Polipropileno
Polypropylene

- Compatible con ref. 36102 y 36105.
Compatible with ref. 36102 and 36105.

TAPA CON ASA

COVER WITH HANDLE



Ref. 36104TA

Pincha QR para ver ficha técnica.



Referencia	Para Marco/Arqueta	M (mm) AxBxC	Peso Kg		€ u.
36104TA20	200 x 200	185 x 185 x 19	0,38	1	6,294
36104TA30	300 x 300	280 x 280 x 21	0,90	1	17,316
36104TA40	400 x 400	380 x 380 x 25	2,110	1	35,298
36104TA55	550 x 550	530 x 530 x 33	7,160	1	100,236



Polipropileno
Polypropylene

- Compatible con ref. 36102 y 36105.
Compatible with ref. 36102 and 36105.

TAPA LIGERA

LIGHT COVER



Ref. 36104TN

Pincha QR para ver ficha técnica.



Referencia	Para Marco/Arqueta	M (mm) AxBxC	Peso Kg		€ u.
36104TN20	200 x 200	185 x 185 x 19	0,21	1	4,003
36104TN30	300 x 300	280 x 280 x 20	0,50	1	11,462
36104TN40	400 x 400	380 x 380 x 25	1,05	1	23,078
36104TN55	550 x 550	530 x 530 x 33	3,88	1	60,204



Polipropileno
Polypropylene

- Compatible con ref. 36102 (excepto 200x200) y 36105.
Compatible with ref. 36102 (except 200x200) and 36105.

No se aceptarán reclamaciones por rotura pasadas 24 horas de la descarga del material en casa del cliente.
Claims are not accepted by breaking past 24 h of delivery of the material at the customer.

ARQUETA

CHEST

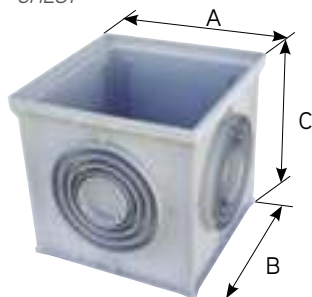

Ref. 36105

Pincha QR para ver ficha técnica.



Referencia	M (mm) AxBxC	Ø salida (mm)	Peso Kg			€ u.
3610520	200 x 200 x 200	Ø50 a 110	0,85	1	140	12,516
3610530	300 x 300 x 300	Ø75 a 125	1,90	1	60	26,283
3610540	400 x 400 x 400	Ø110 a 250	3,96	1	30	46,000
3610555	550 x 550 x 550	Ø160 a 315	7,57	1	16	96,060



- Compatible con ref. 36103, 36104, 36104TA, 36104TN, 36106 y 36107.
Compatible with ref. 36103, 36104, 36104TA, 36104TN, 36106 and 36107.

MARCO

FRAME

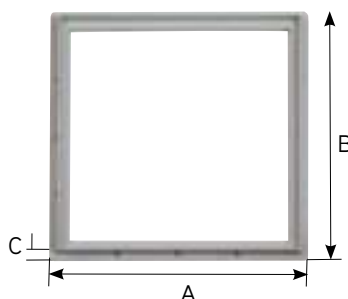

Ref. 36102

Pincha QR para ver ficha técnica.



Referencia	Para Tapa/Rejilla	M (mm) AxBxC	Peso Kg		€ u.
3610220	200 x 200	200 x 200 x 37	0,24	1	6,062
3610230	300 x 300	300 x 300 x 39	0,45	1	8,593
3610240	400 x 400	400 x 400 x 45	0,73	1	11,403
3610255	550 x 550	550 x 550 x 53	1,45	1	20,946

- Compatible con ref. 36103, 36104, 36104TA, 36104TN y 36106.
Compatible with ref. 36103, 36104, 36104TA, 36104TN and 36106.



JUNTA DE GOMA TERMOPLÁSTICA

THERMOPLASTIC RUBBER GASKET



Ref. 36106

Pincha QR para ver ficha técnica.



Referencia	M (mm) AxB	M (mm) AxB		€ u.
3610620	200 x 200	185 x 185	1	12,000
3610630	300 x 300	280 x 280	1	15,050
3610640	400 x 400	380 x 380	1	21,000



- Compatible con ref. 36102 y 36105.
Compatible with ref. 36102 and 36105.

SIFÓN PLACA PARA ARQUETA

TRAP FOR CHEST

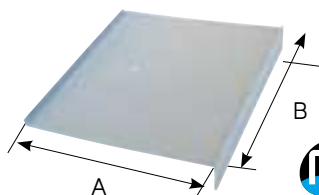

Ref. 36107

Pincha QR para ver ficha técnica.



Referencia	Para arqueta de AxB (mm)	Peso Kg		€ u.
3610720	200 x 200	0,12	1	8,949
3610730	300 x 300	0,21	1	10,996
3610740	400 x 400	0,30	1	15,932
3610755	550 x 550	0,90	1	31,477

- Compatible con ref. 36105.
Compatible with ref. 36105.

No se aceptarán reclamaciones por rotura pasadas 24 horas de la descarga del material en casa del cliente.
Claims are not accepted by breaking past 24 h of delivery of the material at the customer.

SUMIDERO SALIDA VERTICAL

VERTICAL PLASTIC DRAIN



Polipropileno
Polypropylene

Ref. 36100

Pincha QR para ver ficha técnica.



Referencia	M (mm)	Ø salida (mm)		€ u.
3610010	100 x 100 x 45	40	1	2,728
3610015	150 x 150 x 60	50	1	5,677
3610020	200 x 200 x 75	110	1	8,658
3610025	250 x 250 x 80	110	1	11,454
3610030	300 x 300 x 100	110/125	1	18,114

SUMIDERO SALIDA HORIZONTAL

HORIZONTAL PLASTIC DRAIN



Polipropileno
Polypropylene

Ref. 36100H

Pincha QR para ver ficha técnica.



Referencia	M (mm)	Altura (mm)	Ø salida (mm)		€ u.
36100H11	115 x 115	71	50	1	9,232
36100H15	150 x 150	71	50	1	12,432
36100H20	200 x 200	72	50	1	25,576

PARAHOJAS UNIVERSAL

UNIVERSAL LEAVE STOPPER



Polipropileno
Polypropylene

Acero cincado
Zinc plated

Ref. 36101

Pincha QR para ver ficha técnica.



Referencia	Acabado	Ø salida (mm)		€ u.
36101PUP	Plástico	70 / 125	25	2,856
36101PUM	Metálico	75 / 125	5	23,588

TAPA CON MARCO 700 X 700 CLASE A15

REFILLABLE MANHOLE COVER FOR WALL



Polipropileno
Polypropylene

Ref. 38400T

Pincha QR para ver ficha técnica.



Referencia	M (cm)	Color	Resistencia Norma EN 1433		€ u.
38400TN70	70 x 70	Negro	Clase A15	1	175,070
38400TV70	70 x 70	Verde	Clase A15	1	198,250

ARQUETA JARDÍN

GARDEN CHEST

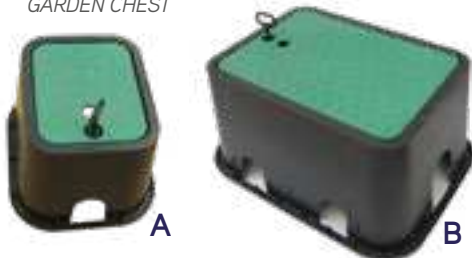

Polipropileno
Polypropylene

Ref. 36450

Pincha QR para ver ficha técnica.



Referencia	T	M (mm)		€ u.
364502427	A	240 x 270 x 175	1	17,121
364504232	B	420 x 320 x 200	1	34,168

No se aceptarán reclamaciones por rotura pasadas 24 horas de la descarga del material en casa del cliente.
Claims are not accepted by breaking past 24 h of delivery of the material at the customer.

BOCA DESAGÜE SIFÓNICA CON REJILLA

SIPHON DRAINAGE OUTLET WITH GRILL



Ref. 36101S

Pincha QR para ver ficha técnica.

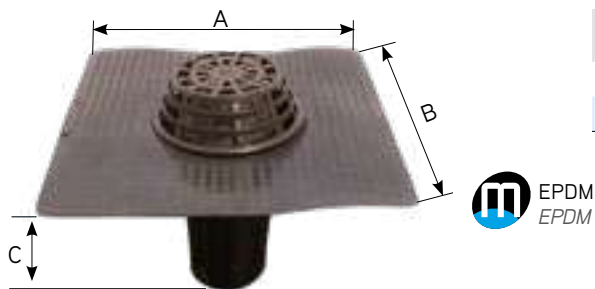

Referencia	M (mm) AxBxC	Ø (mm)		€ u.
36101S090	360 x 360 x 220	90	1	74,535
36101S110	360 x 360 x 220	110	1	76,727

BOCA DESAGÜE

DRAINAGE OUTLET

Ref. 36101

Pincha QR para ver ficha técnica.



Referencia	T	D	Ø ext. (mm)	L (mm)		€ u.
36101090	A	Para tubo Ø 90 PVC	320	240	1	9,954
36101110	A	Para tubo Ø 110 PVC	320	240	1	10,593
36101125	A	Para tubo Ø 120 x 125 PVC	320	240	1	10,692
36101B100	B	Angular 90º 100 x 100	-	-	1	18,585
36101R100	C	Racord angular salida Ø100	-	-	1	15,489
36101B110	D	Angular 90º Ø salida 110	-	-	10	16,703

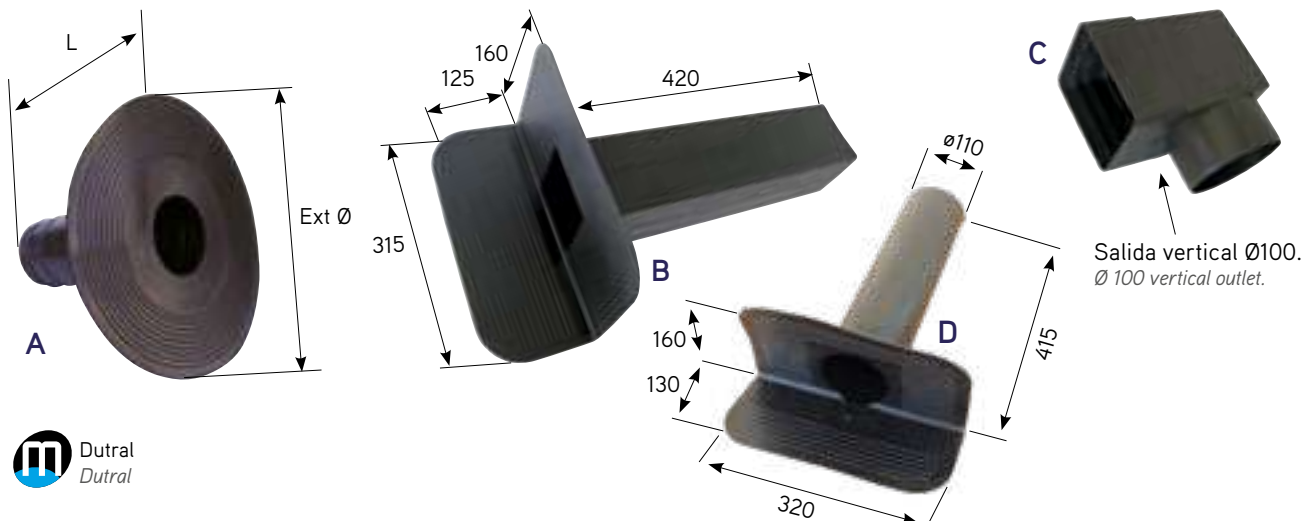

PROTECTOR ANTI-PÁJAROS

BIRD STOPPER



Ref. 36101

Pincha QR para ver ficha técnica.



Referencia	D	Longitud x Altura		€ u.
36101PAP	Pincho Anti-pájaro	50 cm x 2 cm	10	6,642



No se aceptarán reclamaciones por rotura pasadas 24 horas de la descarga del material en casa del cliente.
 Claims are not accepted by breaking past 24 h of delivery of the material at the customer.

TAPA REFORZADA

REINFORCED COVER

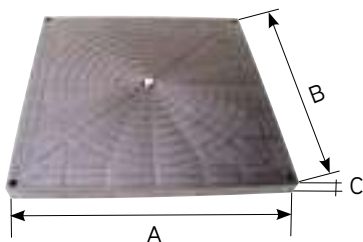

Ref. 36504

Pincha QR para ver ficha técnica.



Referencia	Para Marco/Arqueta	M (mm) AxBxC	Peso en Kg		€ u.
3650420	200 x 200	185 x 185 x 19	0,34	1	7,434
3650430	300 x 300	275 x 275 x 21	0,81	1	15,624
3650440	400 x 400	378 x 378 x 25	2,06	1	31,122
3650455	550 x 550	530 x 530 x 35	4,49	1	77,868



• Compatible con ref. 36502 y 36505.
Compatible with ref. 36502 and 36505.

REJILLA REFORZADA

REINFORCED GRATING

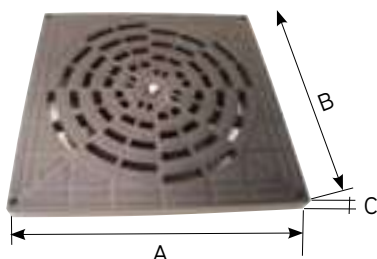

Ref. 36503

Pincha QR para ver ficha técnica.



Referencia	Para Marco/Arqueta	M (mm) AxBxC	Peso en Kg		€ u.
3650320	200 x 200	185 x 185 x 19	0,34	1	7,308
3650330	300 x 300	275 x 275 x 21	0,73	1	15,561
3650340	400 x 400	378 x 378 x 25	1,96	1	31,374
3650355	550 x 550	530 x 530 x 35	4,29	1	77,868



• Compatible con ref. 36502 y 36505.
Compatible with ref. 36502 and 36505.

MARCO

FRAME

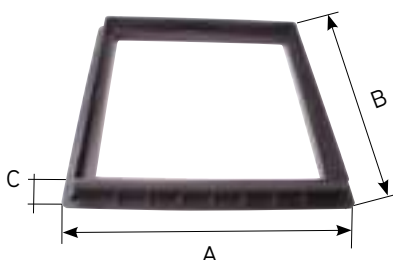

Ref. 36502

Pincha QR para ver ficha técnica.



Referencia	Para Tapa/Rejilla	M (mm) AxBxC	Peso en Kg		€ u.
3650220	200 x 200	200 x 200 x 38	0,22	1	6,804
3650230	300 x 300	300 x 300 x 40	0,48	1	10,395
3650240	400 x 400	400 x 400 x 44	0,70	1	14,301
3650255	550 x 550	550 x 550 x 53	1,20	1	28,665



• Compatible con ref. 36503 y 36504.
Compatible with ref. 36503 and 36504.

ARQUETA

CHEST

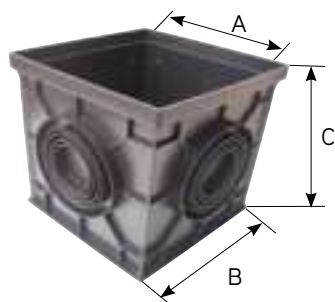

Ref. 36505

Pincha QR para ver ficha técnica.



Referencia	M (mm) AxBxC	Ø salida (mm)	Peso en Kg			€ u.
3650520	200 x 200 x 200	Ø50 a 125	0,81	1	216	11,718
3650530	300 x 300 x 300	Ø75 a 160	1,56	1	72	22,050
3650540	400 x 400 x 400	Ø75 a 250	3,26	1	30	36,351
3650555	550 x 550 x 550	Ø160 a 315	6,03	1	16	85,932



• Compatible con ref. 36503, 36504 y 36507.
Compatible with ref. 36503, 36504 and 36507.

SIFÓN PLACA PARA ARQUETA

TRAP FOR CHEST



Ref. 36507

Pincha QR para ver ficha técnica.



Referencia	Para arqueta de AxB (mm)	Peso en Kg		€ u.
3650730	300 x 300	0,19	1	9,135
3650740	400 x 400	0,39	1	12,915



• Compatible con ref. 36505.
Compatible with ref. 36505.

No se aceptarán reclamaciones por rotura pasadas 24 horas de la descarga del material en casa del cliente.
Claims are not accepted by breaking past 24 h of delivery of the material at the customer.

Complementos



Ref. 36230 | Pág. 145



Ref. 36220 | Pág. 145



Ref. 36220V | Pág. 145



Ref. 69400 | Pág. 146



Ref. 36206 | Pág. 146



Ref. 36200 | Pág. 146



Ref. 36100PVC | Pág. 146



Ref. 55555 | Pág. 147



Ref. 55555 | Pág. 147



Ref. 85100 | Pág. 147



Ref. 85100 | Pág. 147



Ref. 8900H | Pág. 148



Ref. 8900P | Pág. 148



Ref. 88100 | Pág. 148



Ref. 88105 | Pág. 148



Ref. 89096 | Pág. 149



Ref. 89200 | Pág. 149



Ref. 36109P | Pág. 149



Ref. 36109A | Pág. 149

SUMIDERO DE PVC CON CAZOLETA Y REJILLA ACERO INOX. SALIDA HORIZONTAL / VERTICAL

PVC SHOWER DRAIN WITH GUARD AND STAINLESS STEEL GRATING HORIZONTAL / VERTICAL OUTLET

Pincha QR para ver ficha técnica.



Ref. 36230



Referencia	M (mm)	Ø salida (mm)	Altura total (mm)		€ u.
3623010	100 x 100	40	75	1	38,565
3623015	150 x 150	50	80	1	53,417
3623020	200 x 200	90/110	150	1	86,049

Salida horizontal-vertical / Horizontal-Vertical outlet.

Acero inoxidable Aisi 304
Stainless steel Aisi 304

PVC
PVC

SUMIDERO DE PVC CON REJILLA ACERO INOXIDABLE. SALIDA HORIZONTAL / VERTICAL

PVC SHOWER DRAIN WITH STAINLESS STEEL GRATING HORIZONTAL / VERTICAL OUTLET

Pincha QR para ver ficha técnica.



Ref. 36220

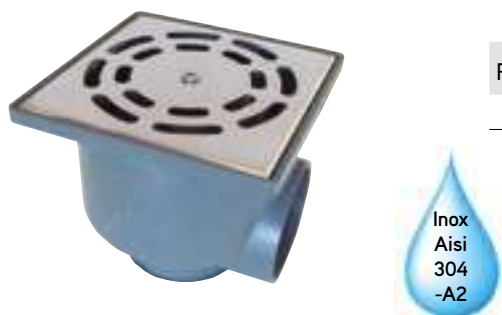

Referencia	M (mm)	Ø salida (mm)	Altura total (mm)		€ u.
3622010	100 x 100	50	90	1	10,530

Salida horizontal-vertical / Horizontal-Vertical outlet.

Acero inoxidable Aisi 304
Stainless steel Aisi 304

PVC
PVC

SUMIDERO DE PVC CON REJILLA ACERO INOXIDABLE BAJA COTA

PVC SHOWER DRAIN WITH STAINLESS STEEL GRATING

Pincha QR para ver ficha técnica.



Ref. 36220V



Referencia	M (mm)	Ø salida (mm)	Altura total (mm)		€ u.
36220V10	100 x 100	40/50	45	1	10,628

Salida vertical / Vertical outlet.

Acero inoxidable Aisi 304
Stainless steel Aisi 304

PVC
PVC

SUMIDERO ACERO INOX AISI 304

AISI 304 STAINLESS STEEL DRAIN

Ref. 69400



Referencia	M (mm)	Ø salida (mm)	Altura total (mm)		€ u.
6940010	100 x 100	40	53	1	68,365
6940015	150 x 150	50	61	1	100,757
6940020	200 x 200	50	67	1	126,487

Acero inoxidable Aisi 304
Stainless steel Aisi 304

SUMIDERO DE PVC CON CAZOLETA, SALIDA HORIZONTAL Y VERTICAL

DRAIN WITH HORIZONTAL AND VERTICAL OUTLET

Ref. 36206

Pincha QR para ver ficha técnica.



Incluye un tapón.

Referencia	M (mm)	Ø salida (mm)	Altura total (mm)		€ u.
3620620	200 x 200	90/110	130	1	54,412
3620625	250 x 250	90/110	140	1	64,307

PVC
PVC

SUMIDERO DE PVC CON CAZOLETA, SALIDA VERTICAL

DRAIN WITH VERTICAL OUTLET

Ref. 36200

Pincha QR para ver ficha técnica.



Referencia	M (mm)	Ø salida (mm)	Altura total (mm)		€ u.
3620020110	200 x 200	90/110	128	1	26,891
3620025110	250 x 250	90/110	143	1	33,215

PVC
PVC

SUMIDERO DE PVC, SALIDA VERTICAL

PVC DRAIN

Ref. 36100 PVC

Pincha QR para ver ficha técnica.



BAJA COTA

Referencia	M (mm)	Ø salida (mm)	Altura total (mm)		€ u.
36100PVC10	100 x 100	40/50	45	1	8,590
36100PVC15	150 x 150	50/75	65	1	11,496
36100PVC20	200 x 200	90/110	85	1	17,404
36100PVC25	250 x 250	90/110	87	1	24,954
36100PVC30	300 x 300	110/125	100	1	48,247

PVC
PVC

CINTA DE ALUMINIO

ALUMINIUM TAPE



Ref. 55555

Referencia	Color	M/R	Ancho en mm		€ rollo
555552290	Gris	50 metros	50	24	18,900
555552250	Blanca	50 metros	50	24	28,350
555552255	Negra	50 metros	50	24	28,350

Longitud en metros. No yardas.



CINTA AMERICANA

AMERICAN TAPE



Ref. 55555

Referencia	M/R	Ancho en mm		€ rollo
555551050	10 metros	50	60	5,472
555555050	50 metros	50	24	21,484

Longitud en metros. No yardas.



PRECINTO DE EMBALAR

SEAL



Ref. 85100

Referencia	M/R	Ancho en mm		€ rollo
85100P132	132 metros	48	36	8,968

Longitud en metros. No yardas.



FILM DE EMBALAR ESTIRABLE MANUAL

PACKING FILM



Ref. 85100

Referencia	Altura (cm)	Peso	Espesor		€ rollo
85100FE500	50	2,2 kg/rollo	23 micras	6	30,173



DISCO ABRASIVO PARA HIERRO

ABRASIVE FOR IRON



Ref. 8900H

Referencia	Ø disco (mm)		€ u.
8900H11510	115 x 1 x 22	25	2,279
8900H11525	115 x 2,5 x 22	25	2,147
8900H23025	230 x 2,5 x 22	25	4,548

Para hierro y acero inoxidable.

DISCO ABRASIVO PARA PIEDRA

ABRASIVE FOR STONE



Ref. 8900P

Referencia	Ø disco (mm)		€ u.
8900P11525	115 x 2,5 x 22	25	2,782
8900P23025	230 x 2,5 x 22	25	6,576

DISCO DIAMANTE GENERAL DE OBRA

DIAMOND UNIVERSAL



Ref. 88100

Referencia	Ø disco (mm)		€ u.
88100115	115	1	16,912
88100230	230	1	41,748

Segmento de 10 mm. Larga duración.
10 mm segment.

Características: Corte en seco.

Aplicaciones: General de construcción, bloque de hormigón, gres, ladrillo y teja.

Characteristics: Dry cutting.

Use: Constuction in general, concrete, stoneware, drill and tile.

DISCO DIAMANTE ESPECIAL PORCELÁNICO

DIAMOND STONEWARE



Ref. 88105

Referencia	Ø disco (mm)		€ u.
88105115	115	1	53,200
88105230	230	1	142,128

Segmento continuo de 8 x 1,8 mm.
Continuous segment of 8 x 1,8 mm.

Características: Corte en seco.

Aplicaciones: Gres porcelánico, gres, cerámica y azulejo.

Characteristics: Dry cutting.

Use: Stoneware, porcelain and glazed tile.

MANGUERA BUTANO

BUTANE HOSE



Ref. 89096

Referencia	Ø (mm)	M/R		€ m.
89096915	9 x 15	60 m	1	3,137

TUBO CRISTAL

GLASS TUBE



Ref. 89200

Referencia	Ø (mm)	M/R		€ m.
89200608	6 x 8	100 m	1	0,727
89200810	8 x 10	100 m	1	0,942
89200812	8 x 12	100 m	1	2,020
89201012	10 x 12	100 m	1	1,131
89201014	10 x 14	100 m	1	2,450
89201215	12 x 15	100 m	1	2,100
89201520	15 x 20	50 m	1	4,470

GÁRGOLA PLÁSTICO ABIERTA BLANCA

OPEN GARGOYLES



Ref. 36109P

Referencia	M (mm)	Color		€ u.
36109PAB	250 x 60	Blanco	50	4,702

GÁRGOLA MARMORES ABIERTA

OPEN GARGOYLES



Ref. 36109A

Referencia	M (mm)	Color		€ u.
36109AB22	220 x 80	Blanco	1	26,730

No se aceptarán reclamaciones por rotura pasadas 24 horas de la descarga del material en casa del cliente.
 Claims are not accepted by breaking past 24 h of delivery of the material at the customer.

Material Autoservicio

 Ref. A1100 Pág. 151	 Ref. A1120 Pág. 151	 Ref. A1107 Pág. 151	 Ref. A1108 Pág. 151	 Ref. A151B Pág. 152
 Ref. A140B Pág. 152	 Ref. A1101 Pág. 152	 Ref. A1103 Pág. 152	 Ref. A180A Pág. 153	 Ref. A5108 Pág. 153
 Ref. A1600 Pág. 153	 Ref. A1409B Pág. 154	 Ref. A5705 Pág. 154	 Ref. A1430 Pág. 154	 Ref. A1329 Pág. 155
 Ref. A1311 Pág. 155	 Ref. A1312 Pág. 155	 Ref. A2215 Pág. 156	 Ref. A2226 Pág. 156	 Ref. A210A Pág. 156
 Ref. A9430 Pág. 156	 Ref. A2100 Pág. 157	 Ref. A2103 Pág. 157	 Ref. A9200 Pág. 157	 Ref. A9250 Pág. 157
 Ref. A2300 Pág. 158	 Ref. A2311 Pág. 158	 Ref. A2910 Pág. 158	 Ref. A2930 Pág. 158	 Ref. A2912 Pág. 159
 Ref. A2920 Pág. 159	 Ref. A2740E Pág. 159	 Ref. A2740G Pág. 159	 Ref. A2700CA Pág. 159	 Ref. A2500 Pág. 160
 Ref. A2500 Pág. 160	 Ref. A2500 Pág. 160	 Ref. A2500 Pág. 160	 Ref. A5100 Pág. 161	 Ref. A8300 Pág. 161
 Ref. A8600 Pág. 161	 Ref. A9210 Pág. 161	 Ref. A9500 Pág. 161	 Ref. A3867 Pág. 162	 Ref. A3867 Pág. 162
 Ref. A3860 Pág. 163	 Ref. A3860 Pág. 163	 Ref. A3860 Pág. 163	 Ref. A3500 Pág. 164	 Ref. A3500 Pág. 164
 Ref. A3500 Pág. 164	 Ref. A3500 Pág. 164	 Ref. A3500 Pág. 164	 Ref. A3120 Pág. 165	 Ref. A3120 Pág. 165
 Ref. A3120 Pág. 165	 Ref. A3121 Pág. 165	 Ref. A3121 Pág. 165	 Ref. A3121 Pág. 165	

BOLSA ABRAZADERA M6

M6 CLAMP

Bolsa 10 unidades



Acero bicromatado
Yellow zinc plated

Apertura lateral
Lateral opening



Ref. A1100

Referencia	Ø (mm)		€ bolsa
A110012	12	20 bolsas	3,252
A110015	15	20 bolsas	3,335
A110016	16	20 bolsas	3,482
A110018	18	20 bolsas	3,541
A110020	20	20 bolsas	3,619
A110022	22	20 bolsas	3,700
A110025	25	20 bolsas	4,184
A110028	28	20 bolsas	4,327
A110032	32	20 bolsas	4,756
A110035	35	20 bolsas	5,082
A110038	38	20 bolsas	5,107
A110040	40	20 bolsas	5,191
A110042	42	20 bolsas	5,486
A110047	47	10 bolsas	7,475
A110050	50	10 bolsas	7,572
A110054	54	10 bolsas	8,781
A110063	63	10 bolsas	9,488

BOLSA ABRAZADERA DOBLE M6

M6 DOUBLE CLAMP

Bolsa 5 unidades



Acero bicromatado
Yellow zinc plated

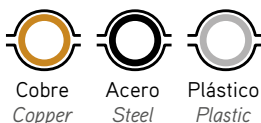

Ref. A1120

Referencia	Ø (mm)		€ bolsa
A112012	12	20 bolsas	2,940
A112015	15	20 bolsas	3,164
A112018	18	20 bolsas	3,267
A112022	22	20 bolsas	3,873

BOLSA ABRAZADERA ISOFÓNICA M6 G/E

M6 CLAMP WITH RUBBER

Bolsa 10 unidades



Acero bicromatado
Yellow zinc plated

Caucho
Rubber

TUBO GAS
GAS PIPE

Apertura lateral
Lateral opening

Reducción de sonido
Sound reduction

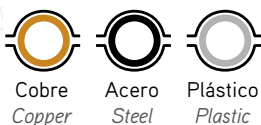

Ref. A1107

Referencia	Ø (mm)		€ bolsa
A110712	12	20 bolsas	4,371
A110715	15	20 bolsas	5,002
A110718	18	20 bolsas	5,253
A110722	22	20 bolsas	5,709
A110726	26	20 bolsas	6,401
A110728	28	20 bolsas	6,621
A110735	35	20 bolsas	8,338
A110742	42	20 bolsas	10,785
A110748	48	20 bolsas	13,156

BOLSA ABRAZADERA ISOFÓNICA DOBLE M6 G/E

M6 DOUBLE CLAMP WITH RUBBER

Bolsa 5 unidades



Caucho
Rubber

Acero bicromatado
Yellow zinc plated

TUBO GAS
GAS PIPE

Reducción de sonido
Sound reduction

Ref. A1108

Referencia	Ø (mm)		€ bolsa
A110812	12	20 bolsas	5,325
A110815	15	20 bolsas	6,025
A110818	18	20 bolsas	6,326
A110822	22	20 bolsas	7,265

BOLSA ABRAZADERA ISOFÓNICA M8 + M10 HYDRAMIX CON TACO Y TIRAFONDO DOWELL M8 X 90

M8 + M10 HYDRAMIX TYPE CLAMP WITH PLUG AND CONNECTING SCREW

Ref. A151B

Bolsa 2 unidades



2 abrazaderas, 2 tacos Ø10 y 2 tirafondos DOWELL M8x90
2 clamps, 2 plugs Ø10 and 2 connecting screws M8x90



Acero cincado
Zinc plated



Reducción de sonido
Sound reduction



Tornillos imperdibles
Safety screws



Cobre
Copper



Acero
Steel



Plástico
Plastic

Referencia	Ø (mm)		€ bolsa
A151B018	18	20 bolsas	3,702
A151B022	22	20 bolsas	3,804
A151B028	28	20 bolsas	3,961
A151B035	35	20 bolsas	4,132
A151B040	40-42	20 bolsas	4,458
A151B048	48-50	20 bolsas	4,768
A151B054	54	20 bolsas	4,990
A151B060	60	20 bolsas	5,231
A151B075	75	20 bolsas	6,158
A151B090	90	20 bolsas	6,505
A151B110	110	20 bolsas	7,795
A151B125	125	10 bolsas	8,575

BOLSA ABRAZADERA M8 + M10 HYDRAMIX CON TACO Y TIRAFONDO DOWELL M8 X 90

M8 + M10 HYDRAMIX TYPE CLAMP WITH PLUG AND CONNECTING SCREW

Ref. A140B

Bolsa 2 unidades



2 abrazaderas, 2 tacos Ø10 y 2 tirafondos DOWELL M8x90
2 clamps, 2 plugs Ø10 and 2 connecting screws M8x90



Acero cincado
Zinc plated



Cobre
Copper



Acero
Steel



Plástico
Plastic



Tornillos imperdibles
Safety screws

Referencia	Ø (mm)		€ bolsa
A140B022	22	20 bolsas	3,241
A140B026	26	20 bolsas	3,393
A140B035	35	20 bolsas	3,564
A140B040	40-42	20 bolsas	3,793
A140B048	48-50	20 bolsas	3,950
A140B054	54	20 bolsas	4,178
A140B060	60	20 bolsas	4,308
A140B075	75	20 bolsas	4,652
A140B090	90	20 bolsas	4,929
A140B110	110	20 bolsas	5,735
A140B115	115	10 bolsas	6,077
A140B125	125	10 bolsas	7,202
A140B160	160	10 bolsas	8,752
A140B200	200	10 bolsas	9,537

BOLSA ABRAZADERA M6 CROMADA

M6 CHROME PLATED CLAMP

Ref. A1101

Bolsa 10 unidades



Tubo de cobre cromado
Chrome plated copper tube



Acero cromado
Chrome plated



Apertura lateral
Lateral opening



Tubo gas
Gas pipe

Referencia	Ø (mm)		€ bolsa
A110110	10	5 bolsas	4,383
A110112	12	5 bolsas	4,549

BOLSA ABRAZADERA M6 CTF NEGRA PINTADA CON TIRAFONDO

M6 BLACK PAINTED CLAMP WITH CONNECTING SCREW

Ref. A1103

Bolsa 10 unidades



Apertura lateral
Lateral opening



Tubo gas
Gas pipe



Cobre
Copper



Acero
Steel



Plástico
Plastic



Acero con recubrimiento negro
Black painted steel

Referencia	Ø (mm)		€ bolsa
A110312	12	20 bolsas	5,775
A110315	15	20 bolsas	5,999
A110318	18	20 bolsas	6,236
A110322	22	20 bolsas	6,710
A110328	28	20 bolsas	7,118
A110335	35	20 bolsas	8,730

BOLSA ABRAZADERA M8 HYDRA 8000 CON TACO Y TIRAFONDO

M8 HYDRA TYPE CLAMP WITH PLUG AND CONNECTING SCREW

Ref. A180A

Bolsa 2 unidades



Referencia	Ø (mm)	📦	€ bolsa
A180A050	50	10 bolsas	4,583
A180A075	75	10 bolsas	4,692
A180A090	90	10 bolsas	4,674
A180A110	110	10 bolsas	4,631
A180A125	125	10 bolsas	4,862
A180A160	160	5 bolsas	6,793
A180A200	200	5 bolsas	8,276

2 abrazaderas, 2 tacos Ø8 y 2 tirafondos M8 x 40
2 clamps, 2 plugs Ø8 and 2 connecting screws M8 x 40

Acero galvanizado
Galvanized steel

Tornillos imperdibles
Safety screws

Plástico
Plastic

BOLSA ABRAZADERA M8 + M10 HYDRAMIX CON TACO Y TIRAFONDO DOWELL

M8 + M10 TYPE CLAMP WITH PLUG AND DOWELL SCREW

Ref. A5108AA

Bolsa 1 unidades



Referencia	Ø (mm)	📦	€ bolsa
*A5108AA100	100	5	9,164
*A5108AA120	120	5	10,286
A5108AA125	125	5	10,379
A5108AA150	150	5	11,501
A5108AA175	175	5	13,091
A5108AA200	200	5	14,587
A5108AA250	250	3	17,205
A5108AA300	300	3	34,597
A5108AA350	350	1	41,143
A5108AA400	400	1	54,234
A5108AA500	500	1	65,454

1 abrazadera, 1 taco y 1 tirafondo Dowell.
Desde Ø120 hasta Ø150 tirafondo Dowel M8 x 60. Taco Ø10.
Desde Ø175 hasta Ø300 tirafondo Dowel M8 x 90. Taco Ø10.
Desde Ø350 hasta Ø500 tirafondo Dowel M10 x 100. Taco Ø12.

Acero galvanizado
Galvanized steel

Tornillos imperdibles
Safety screws

Aluminio
Aluminium

Plástico
Plastic

* Hasta final de existencias / Until end of stocks.

BOLSA ABRAZADERA SIN FIN

WORM HOSE CLIP

Bolsa 10 unidades



Ref. A1600

Referencia	Ø (mm)	📦	€ bolsa
A1600008	8-16	20 bolsas	4,519
A1600012	12-22	20 bolsas	4,715
A1600016	16-27	20 bolsas	4,912
A1600020	20-32	20 bolsas	5,108
A1600025	25-40	10 bolsas	5,697
A1600032	32-50	5 bolsas	6,090
A1600040	40-60	5 bolsas	7,619
A1600050	50-70	5 bolsas	8,036
A1600060	60-80	5 bolsas	8,454
A1600070	70-90	5 bolsas	9,080
A1600080	80-100	5 bolsas	9,706
A1600090	90-110	5 bolsas	10,437
A1600110	110-130	5 bolsas	13,662

Ancho 9 mm.
9 mm wide.

Acero cincado
Zinc plated

BOLSA ABRAZADERA M8 DE ACERO INOXIDABLE AISI 304 CON TACO Y TIRAFONDO DOWELL

M8 STAINLESS STEEL TYPE CLAMP WITH PLUG AND CONNECTING SCREW

* Ref. A1409B

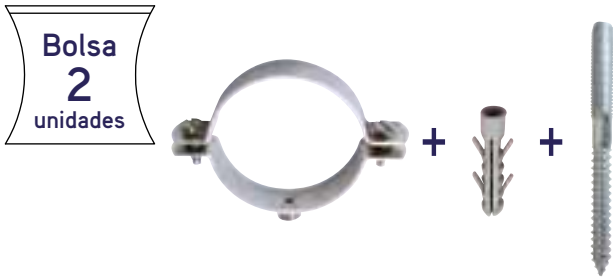

Bolsa
2
unidades

Referencia	Ø (mm)	Dowell MxL (mm)	📦	€ bolsa
A1409B035	35	M8 x 80	5 bolsas	13,535
A1409B060	60	M8 x 80	5 bolsas	15,308
A1409B090	90	M8 x 100	5 bolsas	19,034

* Hasta final de existencias / Until end of stocks.

Acero inoxidable AISI 304
AISI 304 Stainless Steel



Tornillos imperdibles
Safety screws

Cobre
Copper

Acero
Steel

Plástico
Plastic

2 abrazaderas, 2 tacos Ø10 y 2 tirafondos DOWELL
2 clamps, 2 plugs Ø10 and 2 connecting screws

BOLSA ABRAZADERA M8 HYDRA 8000 BLANCA CON TACO Y TIRAFONDO DOWELL M8 X 120

M8 WHITE HYDRA 8000 TYPE CLAMP WITH PLUG AND DOWELL SCREW

Ref. A5705

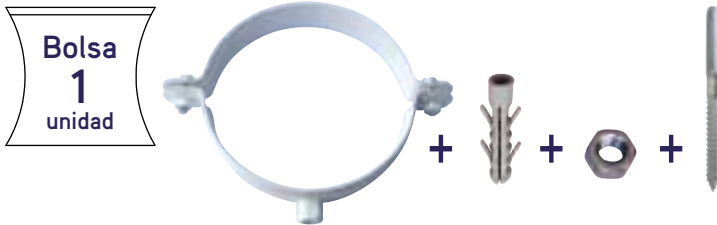

Bolsa
1
unidad

Referencia	Ø (mm)	📦	€ bolsa
A5705AB080	80	10 bolsas	5,537
A5705AB100	100	10 bolsas	6,075
A5705AB125	125	10 bolsas	6,802
A5705AB130	130	10 bolsas	6,834

1 abrazadera, 1 taco Ø10 y 1 tirafondo Dowell M8 x 120 + 1 tuerca M8
1 clamp, 1 plug Ø10 and 1 Dowell screws M8 x 120 + 1 nut M8

Aluminio y chapa blanco
White aluminium

Acero galvanizado
Galvanized steel

Tornillos imperdibles
Safety screws

BOLSA ABARCÓN ACERO INOXIDABLE AISI 304

U-BOLT IN STAINLESS STEEL AISI 304

Ref. A1430



Bolsa
múltiples
unidades

Referencia	Ø P"	R	L	📦	📦	€ U.
A1430018	3/8	M-6	35	10 u.	2 bolsas	21,044
A1430022	1/2	M-6	35	10 u.	2 bolsas	21,830
A1430026	3/4	M-6	35	10 u.	2 bolsas	23,202
A1430035	1"	M-6	35	10 u.	2 bolsas	24,742
A1430040	1" 1/4	M-6	35	10 u.	2 bolsas	26,900
A1430048	1" 1/2	M-8	40	10 u.	2 bolsas	49,921
A1430060	2"	M-8	40	10 u.	2 bolsas	55,584
A1430075	2" 1/2	M-8	40	5 u.	2 bolsas	30,979
A1430090	3"	M-8	40	5 u.	2 bolsas	33,739
A1430115	4"	M-10	40	5 u.	2 bolsas	69,660
A1430140	5"	M-10	40	2 u.	2 bolsas	32,900
A1430160	6"	M-10	40	2 u.	2 bolsas	39,519

Acero
Steel



Equipado con dos tuercas y dos arandelas.
Available with two nuts and two washes.

Acero inoxidable Aisi 304.
Stainless steel Aisi 304

BOLSA ABRAZADERA MÚLTIPLE HYDRA 1000 NYLON

Bolsa
10
unidades



Ref. A1329B

Referencia	Ø (mm)	Color		€ bolsa
A132915B	15-18	Blanco	10 bolsas	3,255
A132920B	20-25	Blanco	10 bolsas	3,900
A132925B	25-32	Blanca	10 bolsas	5,189



VALE PARA GUÍAS:



Poliamida
Polyamide



Rápida instalación
Easy instalation



Libre de halógenos
Halogen free



Ultravioleta
Ultraviolet



Cobre
Copper



Plástico
Plastic

BOLSA CLIP M6 - NYLON

M6 SINGLE NYLON CLIP

Bolsa
10
unidades



Modelo original.
Original model.

Ref. A1311

Referencia	Ø (mm)		€ bolsa
A131112	12	10 bolsas	3,080
A131115	14-15	10 bolsas	3,394
A131118	16-18	10 bolsas	4,169
A131122	20-22	10 bolsas	4,367
A131125	25	10 bolsas	4,516
A131128	28	10 bolsas	5,594



Poliamida
Polyamide



Rápida instalación
Easy instalation



Casquillo de latón
Brass socket



Ultravioleta
Ultraviolet



Libre de halógenos
Halogen free



Cobre
Copper



Plástico
Plastic

BOLSA CLIP DOBLE M6 - NYLON

M6 DOUBLE PLASTIC CLIP

Bolsa
5
unidades



Modelo original.
Original model.

Ref. A1312

Referencia	Ø (mm)		€ bolsa
A131215	14-15	10 bolsas	3,073
A131218	16-18	10 bolsas	3,826
A131222	20-22	10 bolsas	4,128



Poliamida
Polyamide



Rápida instalación
Easy instalation



Libre de halógenos
Halogen free



Casquillo de latón
Brass socket



Ultravioleta
Ultraviolet



Cobre
Copper



Plástico
Plastic

BOLSA TACO ECOPLUSX

ECOPLUSX PLUG

Bolsa
múltiples
unidades



Ladrillo hueco
Hollow brick



Ladrillo macizo
Massive brick



Hormigón
Concrete



Pladur
Cardboard

* Ref. A2226

Referencia	Ø/L (mm)			€ bolsa
A22260630	6 x 30	50 u	20 bolsas	1,959
A22260840	8 x 40	25 u	40 bolsas	1,750

* Hasta final de existencias / Until end of stocks.



Polipropileno
Polypropylene

Con valona. / With ring.

BOLSA TIRAFONDO ABRAZADERA CON TACO

CONNECTIG SCREW WITH PLUG

Bolsa
25
unidades

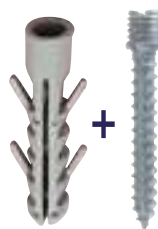

Ladrillo hueco
Hollow brick



Ladrillo macizo
Massive brick



Hormigón
Concrete

Ref. A210A

Referencia	R/L (mm)	Ø Taco (mm)		€ bolsa
A210A0630	M-6 x 30	6	10 bolsas	3,168
A210A0640	M-6 x 40	6	10 bolsas	4,020
A210A0650	M-6 x 50	6	10 bolsas	5,371
A210A0840	M-8 x 40	8	10 bolsas	7,285
A210A0860	M-8 x 60	8	10 bolsas	12,599

25 tacos y 25 tirafondos
25 plugs and 25 screws



Acero cincado
Zinc plated



Poliamida
Polyamide

BOLSA TACO + TORNILLO HEXAGONAL PARA FACHADAS

PLUG + HEXAGONAL SCREW FOR FACADE

Bolsa
6
unidades



Ref. A9430

Referencia	Ø/L (mm)		€ bolsa
A943010080	10 x 80	15 bolsas	12,272



Acero cincado
Zinc plated



Poliamida
Polyamide

BOLSA TACO DE PLÁSTICO DOS CORTES

TWO SLOT PLASTIC PLUG

Bolsa
25
unidades



Ladrillo hueco
Hollow brick



Ladrillo macizo
Massive brick



Hormigón
Concrete

Ref. A2215

Referencia	Ø/L (mm)		€ bolsa
A221505	5 x 20	20 bolsas	1,363
A221506	6 x 22	20 bolsas	0,878
A221507	7 x 23	20 bolsas	1,132
A221508	8 x 25	20 bolsas	1,132
A221509	9 x 30	20 bolsas	1,617
A221510	10 x 40	20 bolsas	1,987
A221512	12 x 47	20 bolsas	3,993



Polietileno
Polyethylene

Con valona. / With ring.

BOLSA TIRAFONDO ABRAZADERA

CONNECTING SCREW

Bolsa
25
unidades

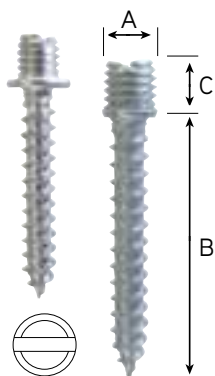

Ref. A2100

Referencia	A x B x C (mm)		€ bolsa
A2100630	M6 x 30 x 6	25 bolsas	2,864
A2100640	M6 x 40 x 6	25 bolsas	4,752
A2100840	M8 x 40 x 7	25 bolsas	8,308

Acero cincado
Zinc plated

BOLSA TIRAFONDO DOBLE ROSCA (DOWELL)

DOUBLE THREADED SCREW (DOWELL)

Bolsa
10
unidades



Ref. A2103

Referencia	R/L (mm)		€ bolsa
A210308080	M-8 x 80	5 bolsas	3,489
A210310100	M-10 x 100	5 bolsas	7,355

Llave Torx-T25

Acero cincado
Zinc plated

BOLSA ANCLAJE HEMBRA

DROP IN ANCHOR

Bolsa
10
unidades



Ref. A9200

Referencia	R	Ø ext. (mm)		€ bolsa
A920006	M-6	8	6 bolsas	1,949
A920008	M-8	10	4 bolsas	2,493
A920010	M-10	12	4 bolsas	5,697
A920012	M-12	15	4 bolsas	15,188

Acero cincado
Zinc plated

BOLSA TACO DE LATÓN

BRASS ANCHOR

Bolsa
10
unidades



Ref. A9250

Referencia	R	Ø ext. (mm)		€ bolsa
A925004	M-4	5	20 bolsas	2,200
A925006	M-6	8	20 bolsas	4,159
A925008	M-8	10	4 bolsas	7,568

Latón
Brass

BOLSA MANGUITO HEXAGONAL

HEXAGONAL SPACER

Bolsa
10
unidades



Acero cincado
Zinc plated

Ref. A2300

Referencia	R/L (mm)		€ bolsa
A23000420	M-4 x 20	25 bolsas	3,533
A23000620	M-6 x 20	25 bolsas	2,887
A23000630	M-6 x 30	25 bolsas	4,545
A23000820	M-8 x 20	20 bolsas	4,554
A23000830	M-8 x 30	20 bolsas	6,321
A23001030	M-10 x 30	10 bolsas	6,563
A23001235	M-12 x 35	5 bolsas	13,338

Disponible en Acero Inox. / Available in stainless steel.

BOLSA ESPÁRRAGO

THREADED ROD

Bolsa
50
unidades



Acero cincado
Zinc plated

Ref. A2311

Referencia	R/L (mm)		€ bolsa
A23110420	M-4 x 20	10 bolsas	5,106
A23110620	M-6 x 20	10 bolsas	7,889
A23110630	M-6 x 30	10 bolsas	9,835
A23110830	M-8 x 30	10 bolsas	16,371

BOLSA TUERCA HEXAGONAL

HEXAGONAL NUT

Bolsa
múltiples
unidades



Acero cincado
Zinc plated

Ref. A2910

Referencia	R			€ bolsa
A291004	M-4	50 u	10 bolsas	1,437
A291006	M-6	50 u	10 bolsas	2,218
A291008	M-8	50 u	10 bolsas	4,389
A291010	M-10	50 u	5 bolsas	14,109
A291012	M-12	50 u	5 bolsas	19,589
A291014	M-14	50 u	5 bolsas	29,499
A291016	M-16	50 u	5 bolsas	35,123
A291018	M-18	20 u	5 bolsas	24,680
A291020	M-20	20 u	5 bolsas	30,956
A291022	M-22	20 u	5 bolsas	39,442

BOLSA ARANDELA PLANA ANCHA

WIDE FLAT WASHER

Bolsa
múltiples
unidades



Acero cincado
Zinc plated

Ref. A2930

Referencia	Ø (mm)			€ bolsa
A293004	4	50 u	10 bolsas	2,439
A293006	6	50 u	10 bolsas	4,985
A293008	8	50 u	10 bolsas	11,217
A293010	10	50 u	10 bolsas	28,644
A293012	12	50 u	10 bolsas	38,300
A293014	14	10 u	5 bolsas	11,325
A293016	16	10 u	5 bolsas	15,121
A293018	18	10 u	5 bolsas	30,974
A293020	20	10 u	5 bolsas	35,194
A293022	22	10 u	5 bolsas	41,143

BOLSA TUERCA HEXAGONAL AUTOBLOCANTE

LOCKNUT

Bolsa
múltiples
unidades



Ref. A2912

Referencia	R			€ bolsa
A291204	M-4	50u.	20 bolsas	1,584
A291212	M-12	25u.	14 bolsas	6,360

Acero cincado
Zinc plated

BOLSA ARANDELA PLANA

FLAT WASHER

Bolsa
múltiples
unidades



Ref. A2920

Referencia	Ø (mm)			€ bolsa
A292016	16	20 u	10 bolsas	8,588
A292018	18	20 u	10 bolsas	10,402
A292020	20	20 u	10 bolsas	16,526
A292022	22	20 u	10 bolsas	19,982

Acero cincado
Zinc plated

BOLSA ARPÓN ESPIGA

SPRING TOGGLE STUD

Bolsa
10
unidades



Ref. A2740E

Pincha QR para
ver ficha técnica.

Referencia	R		€ u.
A2740E04	M-4	10 bolsas	8,041
A2740E06	M-6	10 bolsas	12,400

Acero cincado
Zinc plated

BOLSA ARPÓN GANCHO

SPRING TOGGLE HOOK

Bolsa
10
unidades



Ref. A2740G

Pincha QR para
ver ficha técnica.

Referencia	R		€ u.
A2740G04	M-4	10 bolsas	8,275
A2740G06	M-6	10 bolsas	12,479

Acero cincado
Zinc plated

BOLSA CABEZA ARPÓN

TOGGLE

Bolsa
10
unidades



Ref. A2700CA

Pincha QR para
ver ficha técnica.

Referencia	R		€ u.
A2700CA04	M-4	10 bolsas	3,564
A2700CA06	M-6	10 bolsas	5,192

Acero cincado
Zinc plated

BOLSA FIJACIONES DE SANITARIO

SANITARY SET

Bolsa
2
unidades



Ref. A2500

Referencia	T	D		€ bolsa
A2500CB	C	Vertical 5 x 75 Bicomatado	50 bolsas	1,196
A2500CL	C	Vertical 5 x 75 Latón	50 bolsas	3,091
A2500CITL	C	Vertical 5 x 75 Inox T. Latón	50 bolsas	4,062
A2500CITI	C	Vertical 5 x 75 Inox T. Inox.	50 bolsas	2,951



Hormigón
Concrete



Acero bicomatado
Yellow zinc plated



Latón
Brass



Acero inoxidable
Stainless steel



Poliamida
Polyamide

Bolsa
2
unidades



Ref. A2500

Referencia	T	D		€ bolsa
A2500D	D	Horizontal (tipo góndola)	25 bolsas	2,202



Hormigón
Concrete



Acero bicomatado
Yellow zinc plated

Bolsa
2
unidades

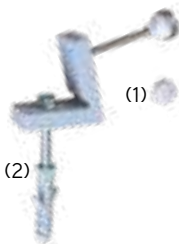

Ref. A2500

Referencia	T	D		€ bolsa
A2500E	E	Fijación WC horizontal	25 bolsas	7,507

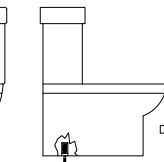

Hormigón
Concrete

(1)



Acero inoxidable
Stainless steel

(2)



Acero cincado
Zinc plated

Bolsa
2
unidades



Ref. A2500

Referencia	T	D		€ bolsa
A2500A08	A	Lavabo 8 x 100 T. Hierro	25 bolsas	1,705
A2500A10	A	Lavabo 10 x 110 T. Hierro	25 bolsas	2,752



Ladrillo hueco
Hollow brick



Ladrillo macizo
Massive brick



Hormigón
Concrete



Acero bicomatado
Yellow zinc plated

BOLSA TUBO FLEXIBLE ALUMINIO

FLEXIBLE ALUMINIUM TUBE



Bolsa
3
metros

Ref. A5100

Referencia	Ø int. (mm)		€ bolsa
A51003100	100	3 metros	15,795
A51003110	110	3 metros	16,077
A51003120	120	3 metros	17,145
A51003130	130	3 metros	19,238

= Metros por bolsa. 1 bolsa es el pedido mínimo.
= Meters per bag. 1 bag minimum order.



BOLSA ARANDELA

WASHER

Bolsa
10
unidades



Ref. A8300

Referencia	D	Ø int. (mm)	Ø ext. (mm)		€ bolsa
A830030	Mix-Redonda	8	30	25 bolsas	1,922

BOLSA APOYAONDAS

WAVE SUPPORT

Bolsa
10
unidades



Ref. A8600

Referencia	D		€ bolsa
A8600M	Mediana	10 bolsas	3,710
A8600G	Grande	10 bolsas	8,022

BOLSA TORNILLO PUNTA BROCA CON ARANDELA Ø16

SCREW DRILL BIT TIP WITH WASHER Ø16

Bolsa
100
unidades



Ref. A9210

Referencia	D	Ø (mm)	L (mm)		€ bolsa
A92104819	4,8 x 19	4,8	19	5 bolsas	17,634
A92105522	5,5 x 22	5,5	22	5 bolsas	20,613
A92106325	6,3 x 25	6,3	25	5 bolsas	29,631

BOLSA TORNILLO AUTORROSCANTE CON ARANDELA Ø16

TAPPING SCREW

Bolsa
100
unidades



Ref. A9500

Referencia	D	Ø (mm)	L (mm)		€ bolsa
A95006325	6,3 x 25	6,3	25	5 bolsas	38,166

KIT 3 METROS CANAL MODELO HSB 100/50 + REJA METÁLICA PASARELA CLASE A15

KIT 3 METERS CANAL MODEL HSB 100/50 + GRATING CLASS A15

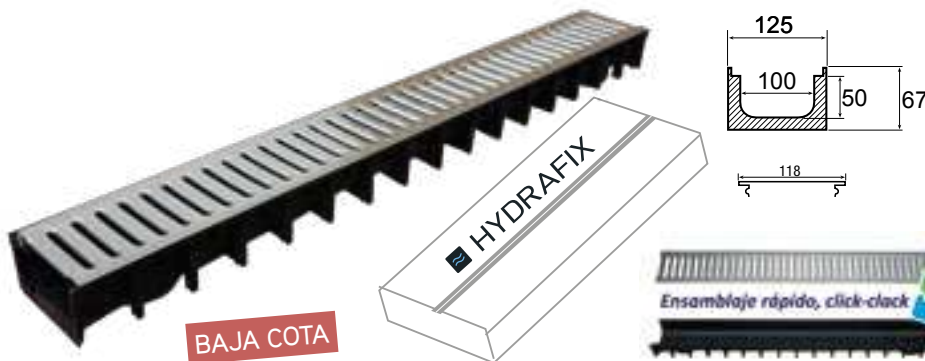

BAJA COTA

Longitud 1 metro.
Salida inferior Ø75-90.
1 m. long.
Bottom outlet Ø75-90.

REJA ACERO GALVANIZADO

Pasarela acero galvanizada clase A15
Peso 1,2 Kg. Long. 1 m.
Resistencia 1500 kg

Ref. A3867



CANAL HSB 100/50.
TAPA INICIO/FINAL

Referencia	Contenido kit		€ kit
A3867K3M1	3 canales de 1 metro HSB modelo 100/50 3 rejas metálicas de 1 metro modelo Pasarela A 15 Sin clavijas solo a presión. 2 tapas de inicio/final.	1 kit	125,514

KIT 3 METROS CANAL MODELO HSB 100/100 + REJA METÁLICA PASARELA CLASE A15

KIT 3 METERS CANAL MODEL HSB 100/100 + GRATING CLASS A15

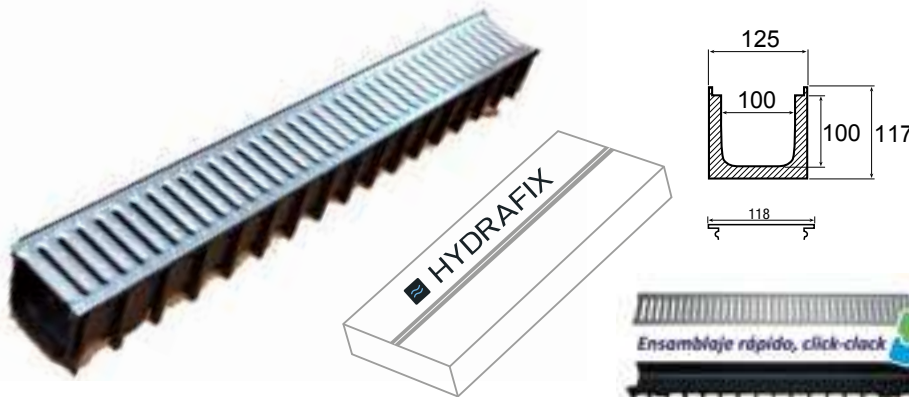

Longitud 1 metro.
Salida inferior Ø75-90.
1 m. long.
Bottom outlet Ø75-90.

REJA ACERO GALVANIZADO

Pasarela acero galvanizada clase A15
Peso 1,2 Kg. Long. 1 m.
Resistencia 1500 kg

Ref. A3867



CANAL HSB 100/100
TAPA INICIO/FINAL

Referencia	Contenido kit		€ kit
A3867K3M2	3 canales de 1 metro HSB modelo 100/100 3 rejas metálicas de 1 metro modelo Pasarela A 15 Sin clavijas solo a presión. 2 tapas de inicio/final.	1 kit	136,684

KIT 3 METROS CANAL HS 100/50 + REJA PLÁSTICO NEGRO

KIT 3 METERS ECOCANAL MODEL 100 + GRATTING BLACK

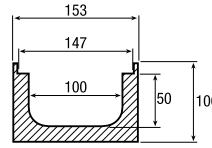

Longitud 1 metro.
Salida inferior Ø110.
1 m. long.
Bottom outlet Ø110.

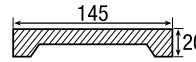

REJA
Polipropileno clase A15
Long. 0,5 m.



Ref. A3860



Referencia	Contenido kit		€ kit
A3860K3M2	3 canales de 1 metro modelo HS 100/50. 6 rejas de 1/2 metro polipropileno. Sin clavijas sólo a presión. 2 tapas de inicio/final.	1 kit	170,000

KIT 3 METROS CANAL HS 100/50 + REJA METÁLICA PASARELA CLASE A15

KIT 3 METERS HS CHANNEL 100/50 + GRATTING CLASS A15

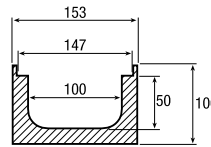

Longitud 1 metro.
Salida inferior Ø110.
1 m. long.
Bottom outlet Ø110.

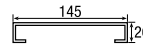

REJA
ACERO GALVANIZADO
Pasarela acero galvanizada A15
Peso 1,5 Kg. Long. 1 m.

Ref. A3860

Referencia	Contenido Kit		€ kit
A3860K3M1	3 canales de 1 metro modelo HS 100/50. 3 rejas metálicas de 1 metro modelo Pasarela A 15. 6 clavijas metálicas + 6 tornillos fijación reja Pasarela. 2 tapas de inicio/final.	1 kit	255,038

KIT 3 METROS CANAL HS 100/50 + REJA FUNDICIÓN CLASE C250

KIT 3 METERS HS CHANNEL 100/50 + GRATTING CLASS C250

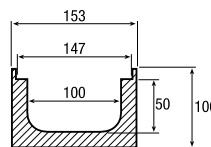

Longitud 1 metro.
Salida inferior Ø110.
1 m. long.
Bottom outlet Ø110.

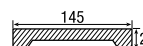

REJA
FUNDICIÓN DÚCTIL
Fundición dúctil C250
Peso 4 kg. Long. 0,5 m.

Ref. A3860

Referencia	Contenido kit		€ kit
A3860K3M9	3 canales de 1 metro modelo HS 100/50. 6 rejas de 1/2 metro modelo Fundición C250. 24 tornillos fijación reja + 24 tuercas 2 tapas de inicio/final.	1 kit	608,770

BOLSA REJILLAS DE PLÁSTICO EN BOLSA CON COLGADOR

PLASTIC GRILLS IN BAG WITH HANGER

Ref. A3500



A

Referencia	T	D	M. interior (cm)	M exterior (cm)		€ bolsa
A3500A	A	Vertical c/marco (shunt)	9,5 x 22	13 x 26	10 bolsas	5,690

Paso de aire 105 cm² / Air passage 105 cm²



H

Referencia	T	D	M. interior (cm)	M exterior (cm)		€ bolsa
* A3500H	H	20 x 20 pestaña	20 x 20	23 x 23	10 bolsas	3,869

Paso de aire 152 cm² / Air passage 152 cm²



I

Referencia	T	D	M. interior (cm)	M exterior (cm)		€ bolsa
A3500I	I	Vertical c/marco y cierre	10,5 x 23,5	13 x 26	10 bolsas	7,015

Paso de aire 69 cm² / Air passage 69 cm²



J

Referencia	T	D	M exterior (cm)	€ bolsa
A3500J	J	Mosquitero para vertical	9 x 21,5	10 bolsas 1,896

Paso de aire 45 cm² / Air passage 45 cm²



M



(con red)

Referencia	T	D	M. interior (cm)	M exterior (cm)		€ bolsa
A3500M	M	Multi desde Ø90 y Ø125 mm	Ø12	Ø15	10 bolsas	3,733



REJILLAS METÁLICAS CON COLGADOR

METALLIC VENTILATION GRATINGS WITH HANGER



15 x 15
Paso de aire 120 cm²
Air passage 120 cm²



17 x 17
Paso de aire 140 cm²
Air passage 140 cm²



20 x 20
Paso de aire 160 cm²
Air passage 160 cm²

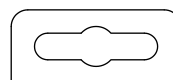

Ref. A3120 con colgador

15 x 15 cm			
Referencia	D		€ u.
A312015A	Aluminio	10 u.	3,257
*A312015M	Madera	10 u.	3,664
A312015AB	Aluminio Blanca	10 u.	3,585

* Hasta final de existencias / *Until end of stocks.*

17 x 17 cm			
Referencia	D		€ u.
A312017A	Aluminio	10 u.	3,745
A312017AB	Aluminio Blanca	10 u.	4,641

20 x 20 cm			
Referencia	D		€ u.
A312020A	Aluminio	10 u.	4,479
*A312020M	Aluminio Madera	10 u.	6,817
A312020AB	Aluminio Blanca	10 u.	4,886

* Hasta final de existencias / *Until end of stocks.*

REJILLAS METÁLICAS CON MOSQUITERA Y COLGADOR

METALLIC VENTILATION GRATINGS WITH SCREEN AND HANGER



Detalle de la mosquitera
de la parte trasera.
Detail of the screen at the back.

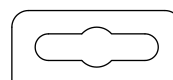

Ref. A3121 con colgador

15 x 15 cm			
Referencia	D		€ u.
A312115A	Aluminio	10 u.	6,152
A312115AB	Aluminio Blanca	10 u.	6,315

17 x 17 cm			
Referencia	D		€ u.
A312117A	Aluminio	10 u.	6,923
A312117AB	Aluminio Blanca	10 u.	8,031

20 x 20 cm			
Referencia	D		€ u.
A312120A	Aluminio	10 u.	7,846
A312120AB	Aluminio Blanca	10 u.	8,308

CATÁLOGO-TARIFA / CATALOGUE-PRICES:

Debido al proceso de mejora continua que realiza HYDRAFIX S.A. las descripciones, fotografías y características de los productos del presente catálogo se entienden como únicamente informativos. HYDRAFIX S.A. se reserva el derecho a modificarlos sin previo aviso.

Due to the continuous improvement process that HYDRAFIX S.A. is always developing, descriptions, pictures and characteristics of all products in this catalogue must be considered as merely informative. HYDRAFIX S.A. reserves the right to make any modification without previous notice.

PRECIOS / PRICES:

En nuestros precios, no está incluido el I.V.A., ni ningún otro impuesto. Los impuestos se cargarán en factura, según determine la legislación vigente. La validez definitiva de los precios consignados en el catálogo general sólo se entenderá como tal desde su confirmación. Mientras, se entenderán sólo como indicativos y por tanto modificables unilateralmente por HYDRAFIX S.A. .

Neither VAT nor any other tax are included in our prices. Taxes will be charged according to current legislation. Prices shown in this catalogue will be definitely valid only upon confirmation. Meanwhile, they should only be considered as indicative and, therefore these prices can be modified by HYDRAFIX S.A. in a unilateral way.

PEDIDOS / ORDERS:

Pedido mínimo 30 euros. Se pagarán al contado todas las compras inferiores a 60 euros.

Minimum order 30 euros. Cash payment is required for all orders under 60 euros.

PORTES / FREIGHT: (Condiciones referidas exclusivamente a España Peninsular, y Baleares / *Terms only applicable to peninsular territory. Please, specify if outside Peninsula.*

Portes pagados, para todos aquellos pedidos que superen un total neto, sin impuestos, de 450 euros en la península (excepto Portugal) y 650 euros en Baleares, entendiéndose como portes pagados la entrega de la mercancía en domicilio del destinatario por la agencia de transportes que determine HYDRAFIX S.A. Portes debidos, para todos los pedidos que no superen estas cantidades netas, sin impuestos, y para los envíos que por deseo expreso del cliente se realicen por transporte urgente, régimen de equipajes, autobús, etc.

Debido al encarecimiento de los portes en el resto de España, Canarias y ciudades autónomas los portes son debidos.

Freight prepaid for all orders over 450 euros (not including taxes) on the peninsula and 650 euros in the Balearic Islands. Freight to addressee's warehouse will be carried out by forwarder appointed by HYDRAFIX S.A. Freight collect for all orders not exceeding these net amounts (taxes not included) and for all orders sent through courier, special luggage regime, coach, etc. upon customer's request.

FACTURACIÓN / INVOICING:

Los compradores tendrán un plazo de quince días improrrogables tras su recepción de mercancía dentro del cual podrán formular, siempre por escrito, sus reclamaciones a la factura, esto es, por razón del momento y lugar del vencimiento, así como sobre el importe a pagar y la manera de hacerlo. Después del transcurso del mencionado plazo sin haberse recibido reclamación alguna sobre la correspondiente factura, HYDRAFIX S.A. tendrá por admitidas cantidad a pagar y condiciones para satisfacerla, sin admitir por tanto ulteriores reclamaciones al respecto.

Buyers will have a fifteen-day term, not extendable, after merchandise reception to claim, always in writing. Claims can only arise on account of expiry date and place, total amount or payment terms. No claims will be admitted after the said period.

PAGOS / PAYMENT:

Mediante giro domiciliado a 30 días de la fecha de factura. Pago al contado 1% de descuento P.P., otras condiciones a convenir. No se efectuarán giros fraccionados.

30 days bank draft. 1% discount applicable to cash payment. Please check for special terms. Bank draft cannot be divided.

GARANTÍAS / GUARANTEE:

HYDRAFIX S.A. sólo se hace responsable de la reposición o sustitución de mercancía vendida por HYDRAFIX S.A. , instalada y utilizada correctamente. Por tanto esta garantía no incluye un posible uso indebido por parte del comprador. El momento de comienzo de la garantía será el indicado en la factura, sin que HYDRAFIX S.A. admita devolución después de 15 días de su envío al comprador.

HYDRAFIX S.A. will only accept responsibility for repairs or replacement of merchandise properly installed and/or used. Consequently, this guarantee excludes any improper use made by the buyer. Guarantee is applicable from invoice date. Returns will not be admitted 15 days after the said date.

TRANSPORTE / TRANSPORT:

La mercancía cuando sale de nuestras instalaciones siempre está en perfectas condiciones. Si no le llega así hágalo constar en el albarán de la agencia de transportes y mándenos la copia por fax para poder hacer la correspondiente reclamación, en un plazo máximo de 24 h. tras su recepción.

Should you not get our merchandise in perfect condition, please register it on forwarder's delivery note. Send us a copy of the corresponding delivery note by fax, allowing us to claim within a 24-hour period.

DEVOLUCIONES / RETURNS:

No se admitirán devoluciones de material transcurridos 15 días a partir de su fecha de recepción por el cliente. HYDRAFIX S.A. exclusivamente admitirá devoluciones con su previo consentimiento escrito. De lo contrario el comprador verá devuelta a cargo de él la mercancía. En la comunicación de la devolución por parte del comprador deberá señalarse motivo y referencia de la factura de compra, junto al albarán listando lo devuelto. Únicamente podrán serle devueltos a HYDRAFIX S.A. , los artículos incluidos en su catálogo en vigor. Lo devuelto deberá enviarse sufragando los gastos el cliente y tendrá al menos un 20% de cargo por manipulado. Los gastos de transporte serán por cuenta del cliente.

No returns will be accepted after 15 days from its reception at customer's. HYDRAFIX S.A. will only accept returns previously authorised in writing. On the contrary, merchandise will be re-send to the customer's, freight collect. For all returns, customers must indicate the reason causing it and the invoice reference, adding delivery note listing all goods returned. HYDRAFIX S.A. will only accept returns of products appearing in current catalogue. Returns will get a 20% charge for handling cost. Freight cost for returns must be met by customer.

IMPORTANTE / IMPORTANT

No se admitirán pedidos inferiores a la cantidad indicada en la columna envase  .

No orders will be admitted if quantity per item is below that shown in column for packing  .

JURISDICCIÓN / JURISDICTION:

Ambas partes se someten, con renuncia a su propio fuero, a los tribunales de Valencia.

Both parts to be subjected to Valencia Court, with express waiver of their own jurisdiction.

INFORMACIÓN TÉCNICA

ABRAZADERA REFORZADA HYDRASOL DACROMET



Abrazadera de alta calidad disponible en versión metálica e isofónica con una amplia gama de medidas.

Soldadura por cordón de en todo su contorno, soportando altas cargas de rotura de hasta 8kN.



Recubrimiento tipo dacromet compuesto por láminas de zinc y de aluminio y óxidos de cromo, ofreciendo una elevada protección en ambientes corrosivos. Resistencia en ensayo de corrosión en niebla salina neutra según UNE EN ISO 9227:17 de hasta 1.000 horas sin aparición de corrosión roja.

GUIAS METÁLICAS

Nuestras guías metálicas pertenecientes a la familia 1590G han sido sometidas a diferentes ensayos en institutos tecnológicos acreditados por la ENAC para asegurar la resistencia a flexión de las guías metálicas en diferentes situaciones.

Carga en un punto:

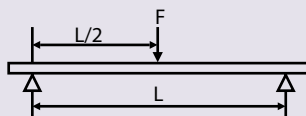

Carga concentrada en 2 puntos:

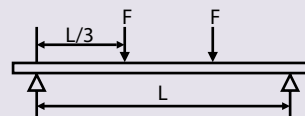

Carga concentrada en 3 puntos:

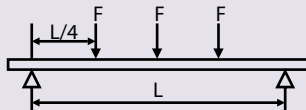

Carga uniforme:

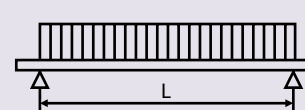

Ensayo: Nº 21805686 del 28/05/2019

Acreditación: Laboratorio de Ensayos Mecánicos. AIDIMME

UNE EN 124



Clase A15: Áreas que sólo pueden ser utilizadas por peatones y ciclistas.



Clase B125: Áreas peatonales y similares, áreas de estacionamiento o aparcamiento para coches.



Clase C250: Áreas de cunetas de los arcenes de carreteras que, cuando se miden desde el extremo del bordillo de la acera, se extienden un máximo de 0,5m sobre la calzada y un máximo de 0,2m sobre el área peatonal.



Clase D400: Áreas de calzadas de carreteras, arcenes estabilizados y áreas de aparcamiento, para todo tipo de vehículos.





INFORMACIÓN ADICIONAL

Estos son los diferentes departamentos a los que puede dirigirse para su mejor atención:

Departamento	Correo electrónico	Teléfono	Fax*
Atención al Cliente	clientes@hydrifix.es	961 669 036	900 151 990
Atención al Cliente	pedidos@hydrifix.es	609 274 966	900 151 990
Atención al Cliente	comercial@hydrifix.es	961 669 036	900 151 990
Calidad	calidad@hydrifix.es	961 668 661	900 151 990
Contabilidad	contabilidad@hydrifix.es	961 668 661	900 151 990
Administración	administracion@hydrifix.es	961 668 661	900 151 990
Gerencia	gerencia@hydrifix.es	961 668 661	900 151 990

* FAX GRATUITO

SIMBOLOGÍA / SYMBOLS

∅	Diámetro / <i>Diameter</i>		Bolsa / <i>bag</i>
	U. Envase / <i>U. Packing</i>	L	Longitud / <i>Length</i>
	U. Embalaje / <i>U. Packing case</i>	R	Rosca / <i>thread</i>
	Colgador / <i>Hanger</i>	Mo	Modelo / <i>Model</i>
T	Tipo / <i>Type</i>	Kg	Peso / <i>Weight</i>
M	Medidas / <i>Measure</i>	Ar	Arandela / <i>Washer</i>
M/R	Metros por rollo / <i>Mts Roll</i>	De	Descripción / <i>Description</i>
D	Denominación / <i>Denomination</i>	Ref.	Referencia / <i>Reference</i>
P"	Pulgadas / <i>Inch</i>	€ m.	Euros metro / <i>Euros metre</i>
	Bolsa con colgador / <i>bag with hanger</i>	€ u.	Euros unidad / <i>Euros unit</i>

NUEVO HORARIO ATENCIÓN AL CLIENTE / RECOGIDAS

Lunes a Jueves	8:00 - 13:00 15:00 - 18:00
Viernes	8:00 - 14:30

HYDRAFIX

C/ Poniente, 11A · Pol. Ind. Bassa
46190 Ribarroja del Turia (Valencia) España
Aptdo. Correos 169

Teléfono: (+34) 961 669 036
Tel. móvil: 609 274 966
Fax: 900 151 990

E-mail: pedidos@hydrafix.es
Web: www.hydrafix.es

